



## GSP 670

Gaming Headset with low latency connection and Bluetooth® connectivity

## GSA 70

2.4 GHz RF USB Dongle



# Contents

<b>The GSP 670 headset</b> .....	<b>2</b>
<b>Package contents</b> .....	<b>2</b>
<b>Product overview</b> .....	<b>3</b>
Overview of the GSP 670 headset.....	3
Overview of the GSA 70 dongle.....	3
Overview of the LEDs .....	4
<b>Getting started</b> .....	<b>5</b>
Connecting the headset via USB cable and charging the headset battery .....	5
Pairing the headset with wireless devices.....	6
Installing the Sennheiser Gaming Suite .....	9
Changing Audio settings for Microsoft® Windows .....	9
Individually adjusting the headset .....	10
<b>Using the headset</b> .....	<b>11</b>
Switching the headset on.....	11
Establishing a wireless connection (Bluetooth or low latency channel) .....	11
Changing the volume .....	12
Muting the headset’s microphone .....	13
Verifying remaining battery power .....	13
Charging and storing the headset.....	14
Reconnecting wireless devices and waking up the headset from sleep mode .....	15
Switching the headset off .....	15
Using and changing settings for the smart button .....	15
<b>Maintaining and updating the products</b> .....	<b>16</b>
Replacing the ear pads.....	16
Exchange cover plates.....	16
Updating the firmware of the products .....	17
Replacing/removing the headset’s rechargeable battery .....	17
Clearing the pairing list of the headset (Reset).....	18
Clearing the pairing list of the dongle (Reset).....	18
<b>Specifications</b> .....	<b>19</b>

## The GSP 670 headset

The new GSP 670 wireless gaming headset, combines the HiFi audio performance of the GSP 600 with advanced features and wireless connectivity. Through the **Sennheiser Gaming Suite** the headset will get even more features unlocked, and delivers cutting edge audio performance.

### Connectivity

The headset can be connected to the PC or PS 4™ either via USB or through the Wireless Dongle. Furthermore the headset offers Bluetooth 5.0 connectivity to Bluetooth compliant devices.

### Features

- **Low latency connection to dongle GSA 70** for better performance in situations where picture and audio is linked such as Gaming and Video
- **Bluetooth connection** to any compliant Bluetooth device
- **Separated chat and game audio** with two different volume wheels – for PC only
- **On the fly adjustments** of game audio and microphone mute
- **Smart button** to quickly toggle between settings. As standard this will toggle between different profiles in the headset. These profiles can be adjusted in the Sennheiser Gaming Suite.
- **Adjustable contact pressure** via the headband for perfect wearing comfort
- **Memory foam ear pads** in high quality material for minimal irritation over longer gaming sessions
- **USB charging**
- **Battery times** up to 16 hours over low-latency connection and up to 20 hours via Bluetooth

### Sennheiser Gaming Suite (SGS)

The Sennheiser Gaming Suite, is a free of charge software for PCs with Microsoft® Windows and offers additional features for the headset. The software also allows to update the firmware of headset and dongle.

### Additional Sennheiser Gaming Suite features

- **Sennheiser Binaural Rendering Engine** – best in class surround sound for headphones with options to customize settings such as reverberation
- **Fully customizable equalizer settings**
- **Side tone adjustments** so you can hear your own voice in the headset
- **Set noise reduction aggressiveness** in the software including the noise gate
- **Microphone equalizer** – makes your voice sound warmer or increases speech intelligibility
- **Firmware update** for headset and dongle

## Package contents

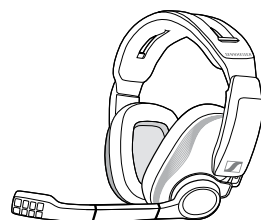

GSP 670  
Bluetooth headset with  
built-in rechargeable  
Lithium-Polymer battery

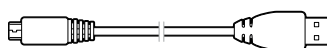

USB cable

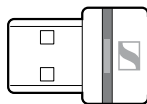

GSA 70  
2.4 GHz low latency  
dongle



Quick Guide  
Safety Guide  
Compliance sheet



For safety instructions, consult the Safety Guide.



A list of accessories can be found on the product page at [www.sennheiser.com/GSP670](http://www.sennheiser.com/GSP670). For information on suppliers, contact your local Sennheiser partner: [www.sennheiser.com/GSP670](http://www.sennheiser.com/GSP670) > "Find a dealer".

# Product overview

## Overview of the GSP 670 headset

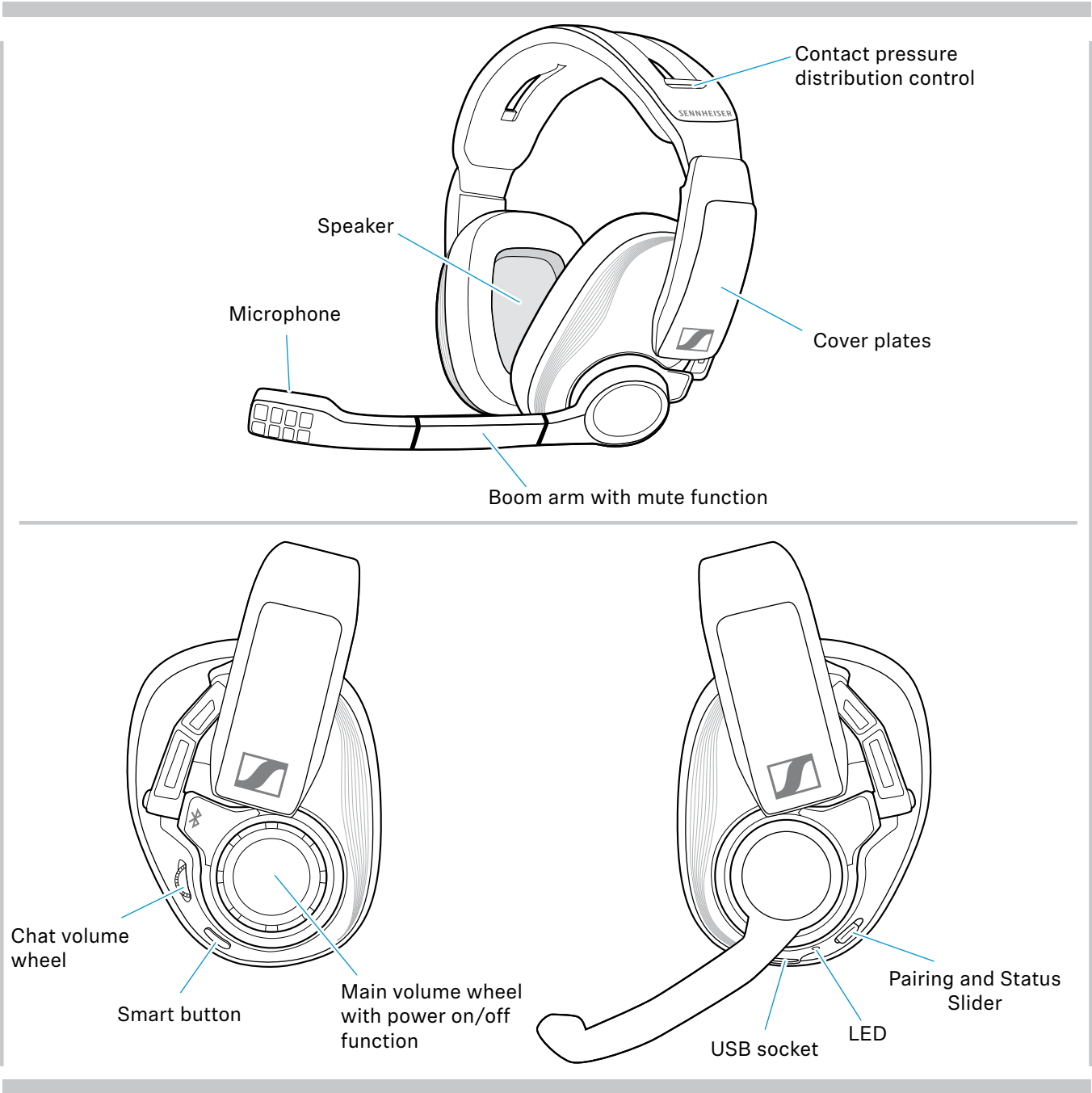



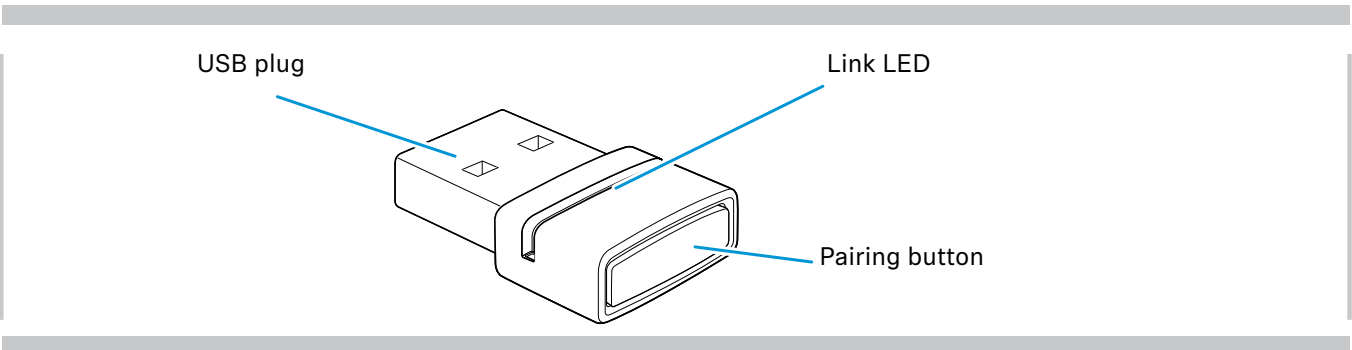





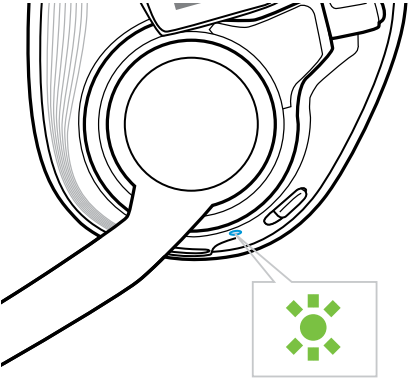







## Overview of the GSA 70 dongle











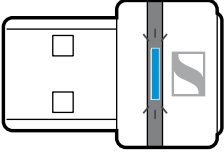

## Overview of the LEDs

### Overview of the headset LED

Headset	LED	Meaning
	↓ 3x  ↓ ...	Headset switches on
	↓  ↓ ...	<ul style="list-style-type: none"> <li>Headset is connected via USB cable</li> <li>Headset is being charged</li> </ul>
	↓  ↓  ↓  ↓  ↓ ...	Headset is in pairing mode
	↓ 3x  ↓ ...	Pairing to mobile device was successful*
	↓ 3x  ↓ ...	Pairing to Dongle was successful*
	↓ 3x  ↓ ...	Pairing has failed or has been cancelled
	↓ 3x  ↓ 3x  ↓  ↓ ...	Headset switches off
	↓  ↓  ↓  ↓  ↓ ...	Rechargeable battery is weak

\*Once the headset is successfully connected, the LED goes off.

### Overview of the dongle LED

Dongle	LED	Meaning
	↓  ↓  ↓  ↓  ↓ ...	Dongle in pairing mode: searching for headsets to pair and connect
	↓ 3x  ↓ ...	Pairing successful
	↓ 3x  ↓ ...	Pairing failed
	↓  ↓ 2s ↓  ↓ 2s ↓ ...	Dongle tries to connect to the headset
	↓  ↓ ...	Dongle and headset connected

## Getting started

You can connect the headset:

- via the **USB cable** to a PC or PS4™ (Playstation® 4 | Playstation® 4 Pro) **A** or
- via **Bluetooth** to a mobile device (e.g. smartphone, tablet) **B** or
- via the Dongle (low latency connection) to a PC **C** or PS4™ **D**.



If you connect the headset via USB cable **A** it will automatically be charged.

### Connecting the headset via USB cable and charging the headset battery

#### Connecting the headset via USB cable to a PC

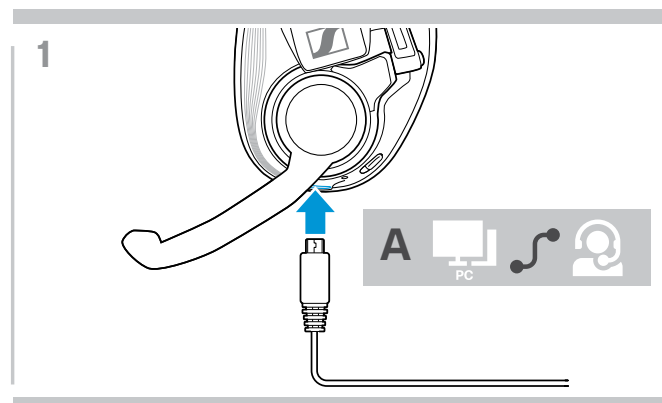

- ▶ Connect the small plug of the USB cable to the USB socket of the headset.

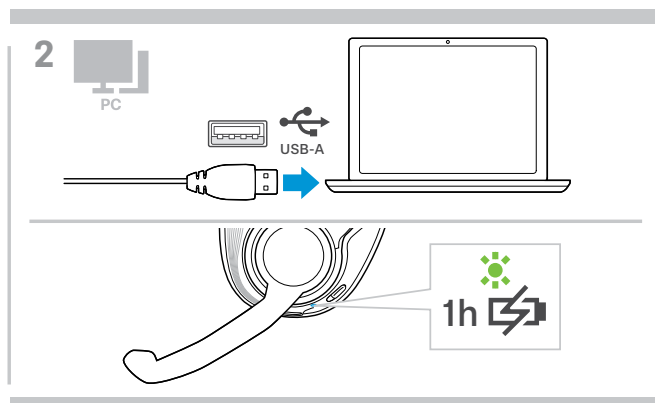

- ▶ Connect the other plug of the USB cable to the USB socket of your PC. The LED lights up green. The battery is being charged.
- ▶ Install the Sennheiser Gaming Suite (see page 9).

#### Connecting the headset via USB cable to a PS4™

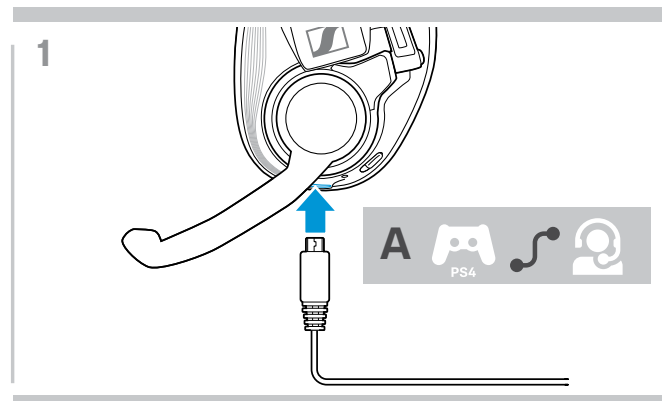

- ▶ Connect the small plug of the USB cable to the USB socket of the headset.

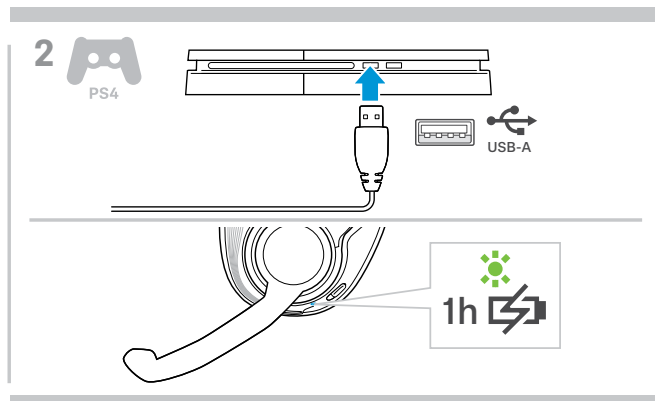

- ▶ Connect the other plug of the USB cable to the USB socket of your PS4™. The LED lights up green. The battery is being charged.



## Pairing the headset with wireless devices



### CAUTION

**Danger of malfunction!**

The transmitted radio waves of mobile devices can impair the operation of sensitive and unprotected devices.

▷ Only make calls with the headset in locations where wireless Bluetooth transmission is permitted.

You can connect the headset either via Bluetooth to mobile device (e.g. smartphone, tablet) **or** together with the Dongle GSA 70 to a PC or PS4™. In order that data can be transmitted wirelessly, you have to pair your headset first. The delivered Dongle is already paired with the headset.

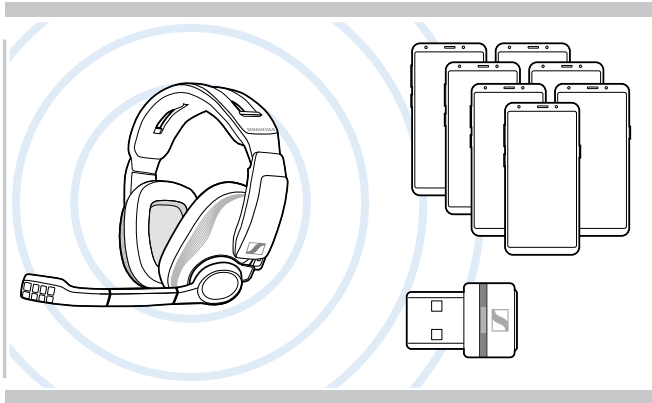

The headset complies with the Bluetooth 5.0 standard. Bluetooth devices need to support the “hands free profile” (HFP), the “headset profile” (HSP) or the “advanced audio distribution profile” (A2DP).

The headset can save up to eight paired devices.

If you pair the headset with a ninth device, the first device in the pairing list will be overwritten. If you want to re-establish a connection with this device, you have to pair it again.

### Pairing the headset via Bluetooth with a mobile device

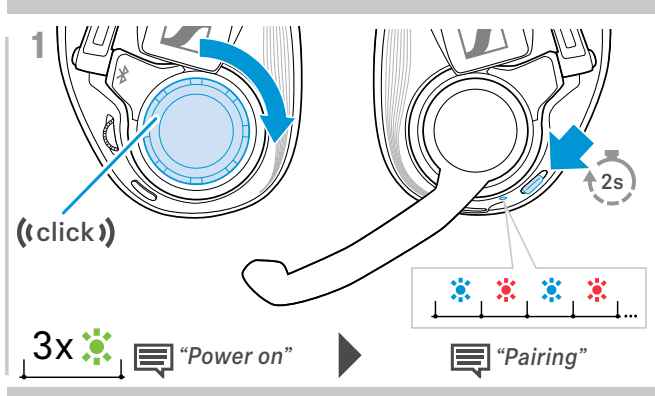

▷ Turn the main volume wheel over a slight resistance to turn the headset on.

▷ Slide and hold the Pairing Slider until the LED alternately flashes blue and red. The headset is in pairing mode.

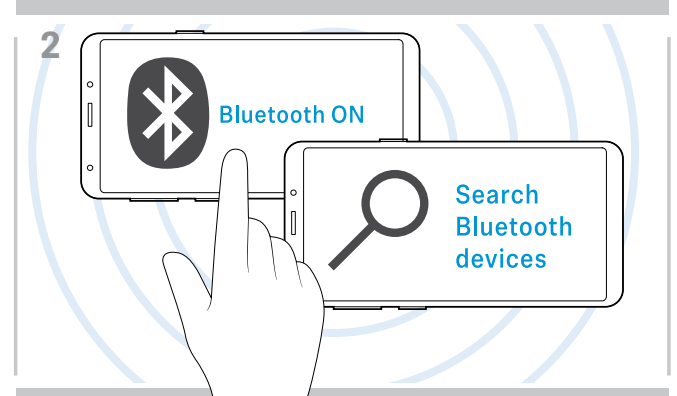

▷ Enable the Bluetooth visibility on your mobile device (see instruction manual of your mobile device).

▷ Start a search for Bluetooth devices. All available devices in the proximity of the mobile device are displayed.

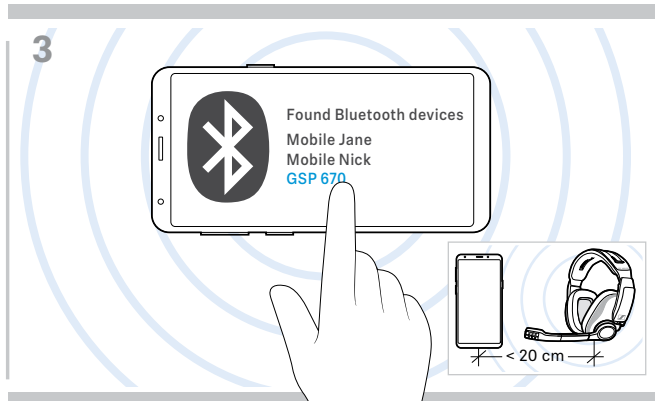

▷ Select “GSP 670” to establish a Bluetooth connection to the headset.

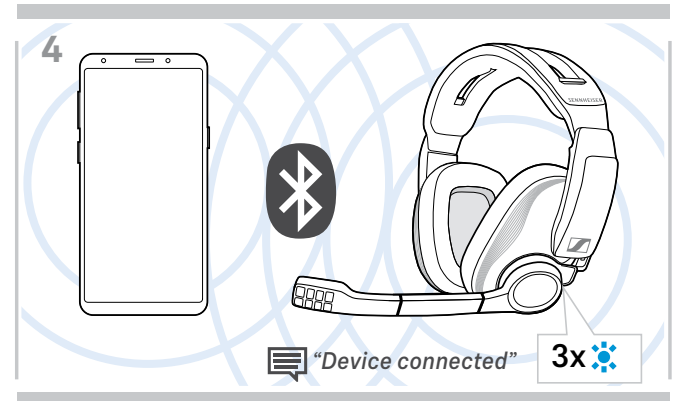

Once the headset is paired with the mobile device, the LED goes off.

## Plugging-in the dongle for wireless connection to PC or PS4™

The dongle GSA 70 and the headset in the bundle are already paired.

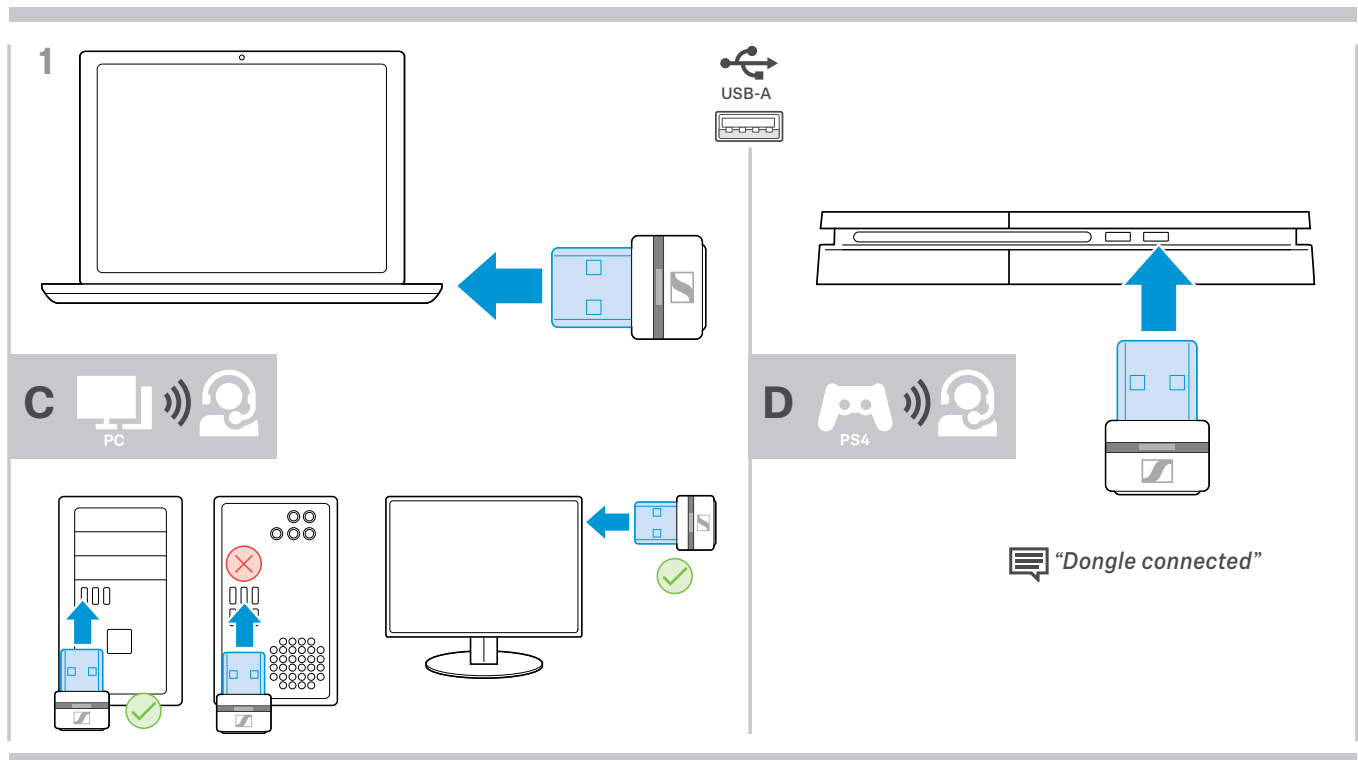

- ▶ Plug the dongle into a USB-A port of your PC or PS4™.  
For desktop PCs:  
Use a port on the front of the housing **or** on your monitor **or** keyboard.  
The connection on the rear might lead to disturbances.

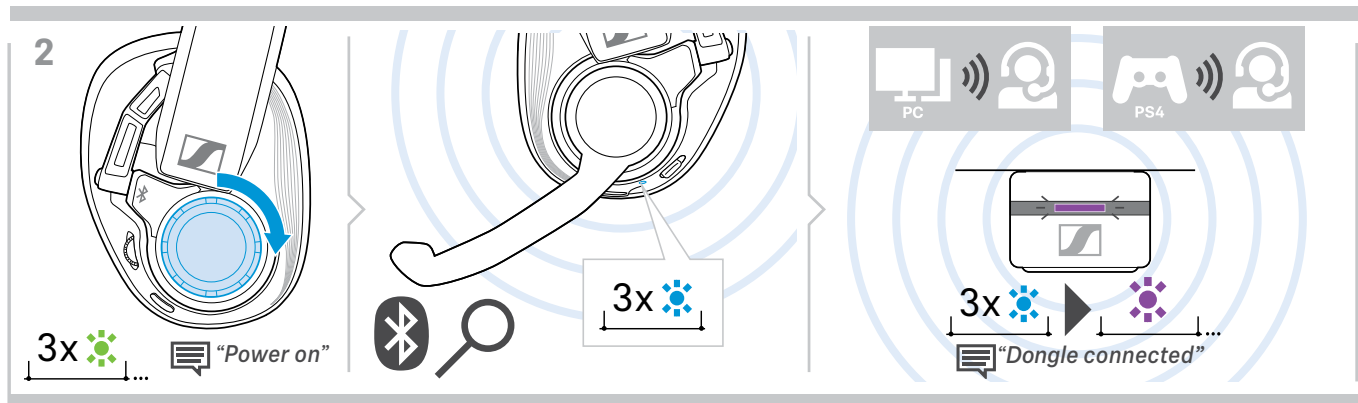

- ▶ Turn the main volume wheel over a slight resistance to turn the headset on.  
The headset searches for paired devices.  
Once the dongle and the headset are connected, both LEDs flash 3 times blue.  
Headset LED turns off, dongle LED lights up constant.

If you use the Dongle with the PC:

- ▶ Install the Sennheiser Gaming Suite (see page 9).



### Pairing a friend's or new dongle

If you use a friend's or new accessory\* dongle, you have to pair the dongle and the headset.

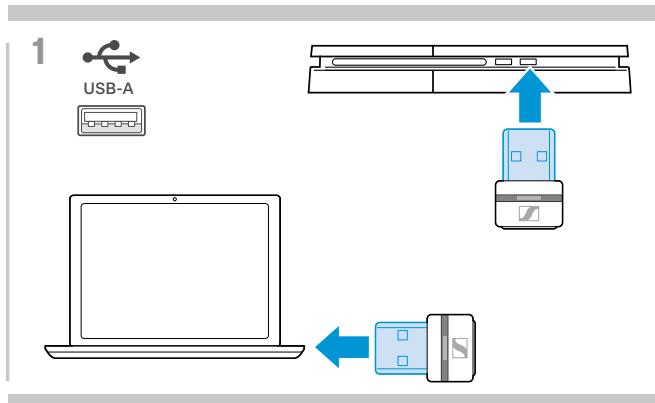

- ▶ Plug the dongle into a USB-A port of your PC or PS4™.
- ▶ Switch the headset on (see page 11).

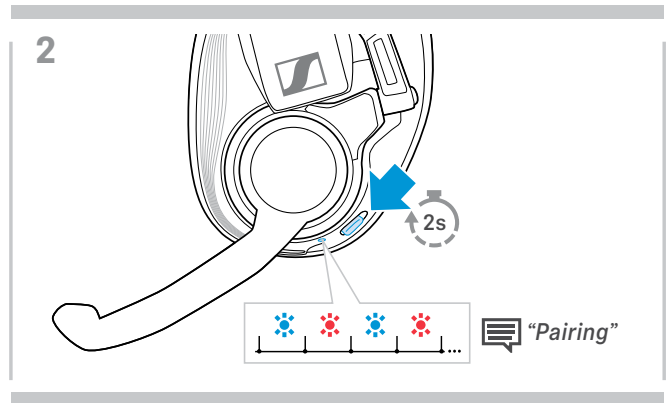

- ▶ Slide and hold the Pairing Slider until the LED alternately flashes blue and red. The headset is in pairing mode.

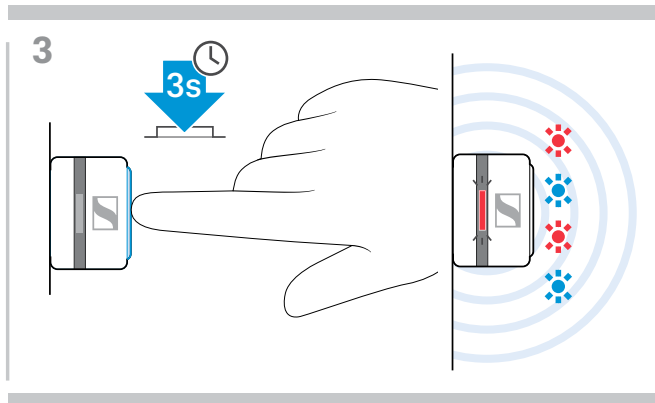

- ▶ Press and hold the dongle's button until the LED alternately flashes blue and red. The dongle is in pairing mode.

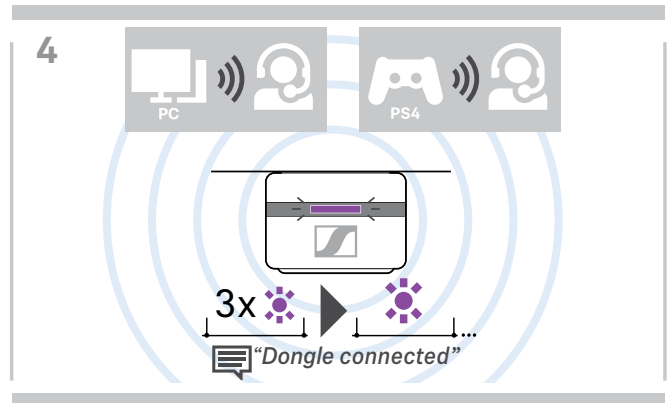

Once the dongle and the headset are connected, both LEDs flash 3 times purple and then light up constant purple.

**i** It may take a few moments for the devices to find each other and connect.

\*Accessories can be found on the product page at [www.sennheiser.com/GSP670](http://www.sennheiser.com/GSP670).

## Installing the Sennheiser Gaming Suite

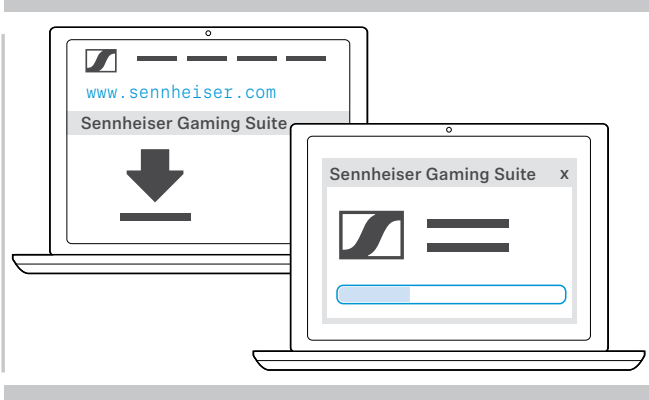

The Sennheiser Gaming Suite enables headset configurations e.g. of the Smart button, equalizer, side tone, noise reduction and update of your devices.

Visit our website further features and details:  
[www.sennheiser.com/GSP670](http://www.sennheiser.com/GSP670).

- ▶ Download the software from [www.sennheiser.com/gaming-downloads](http://www.sennheiser.com/gaming-downloads).
- ▶ Install the software.

## Changing Audio settings for Microsoft® Windows

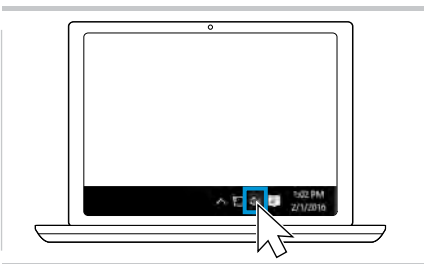

1. Right-click the Audio icon.

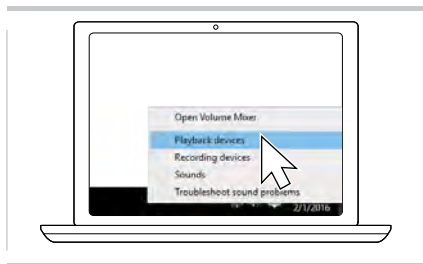

2. Select "Playback devices".



3. The "Sounds" window appears.

### Setting up GSA 70 as Speaker and headphone

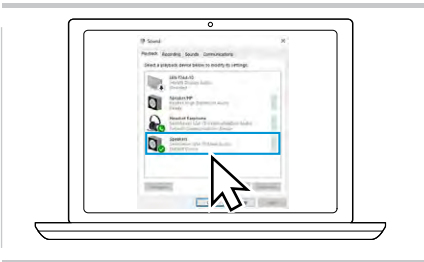

4. Select "Speakers – GSA 70 Main Audio".

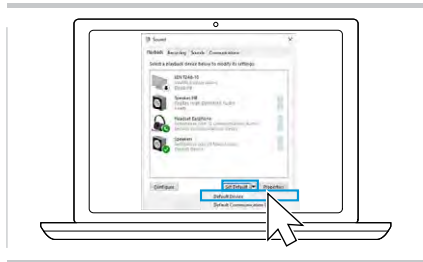

5. Click "Set Default" and select "Default Device".

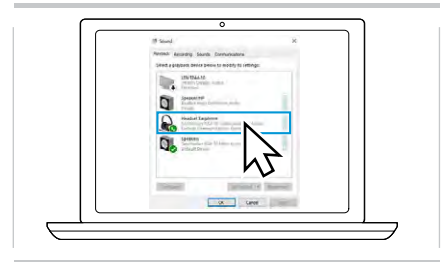

6. Select "Headset Earphone – GSA 70 Communication Audio".

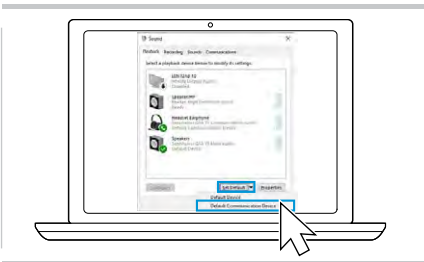

7. Click "Set Default" and select "Default Communication Device".

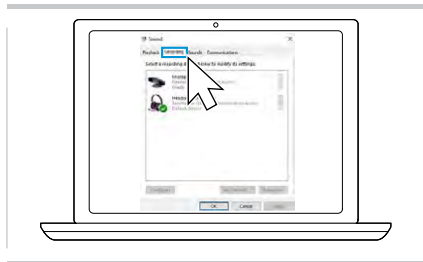

8. Select tab "Recording".

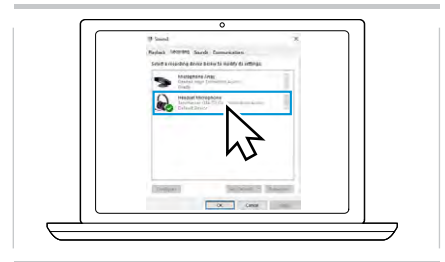

9. Select "GSA 70 Communication Audio".

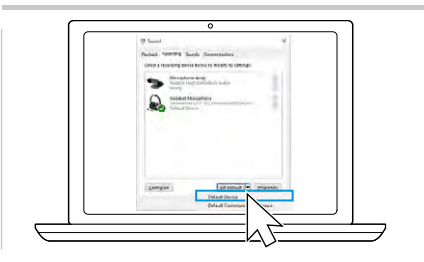

10. Click "Set Default" and select "Default Device".

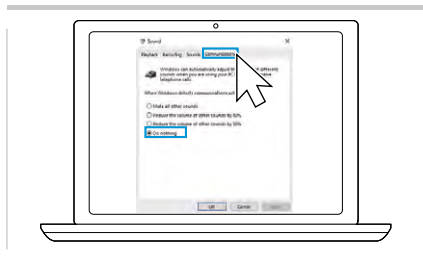

11. Select tab "Communications" and activate "Do nothing".

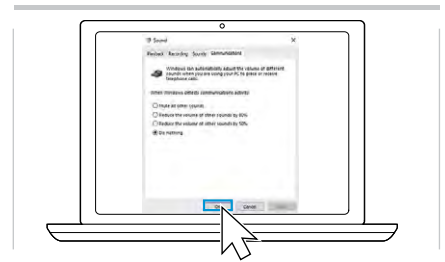

12. Click "OK" to save settings and close the window.

## Individually adjusting the headset

For good sound quality and best possible wearing comfort, the headset has to be adjusted to properly fit your head.

- ▷ Wear the headset so that the headband runs over the top of your head.

### Adjusting the headband and the boom arm

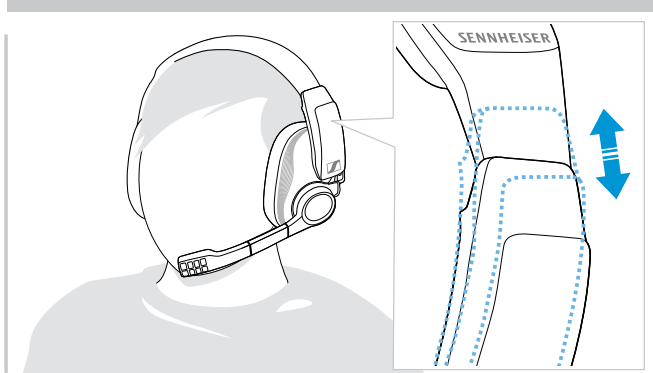

- ▷ Adjust the headset so that
  - your ears are comfortably covered by the ear pads,
  - you feel even, gentle pressure around your ears,
  - a snug fit of the headband on the head is ensured.

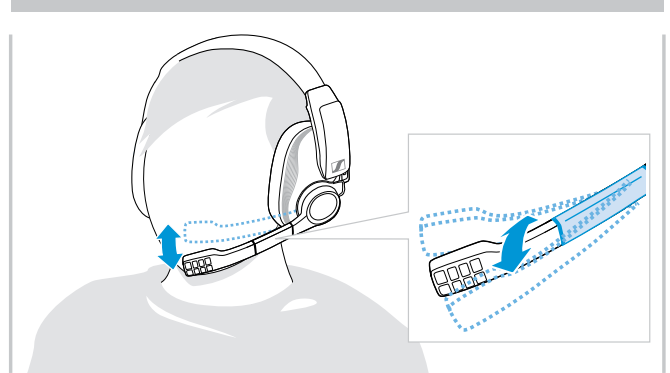

- ▷ Bend the microphone boom so that the microphone is in line with your mouth and about 0.8" (2 cm) from the corner of your mouth.

### Changing the contact pressure distribution

The headset pressure distribution may feel extra tight right out of the box, but the pressure will decrease slowly over time. You can also adjust the pressure:

- ▷ Slide both Contact pressure distribution controls:

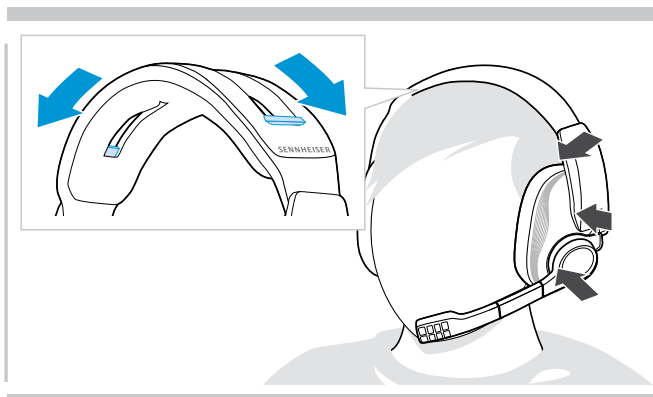

- down to reduce the pressure on the ears.

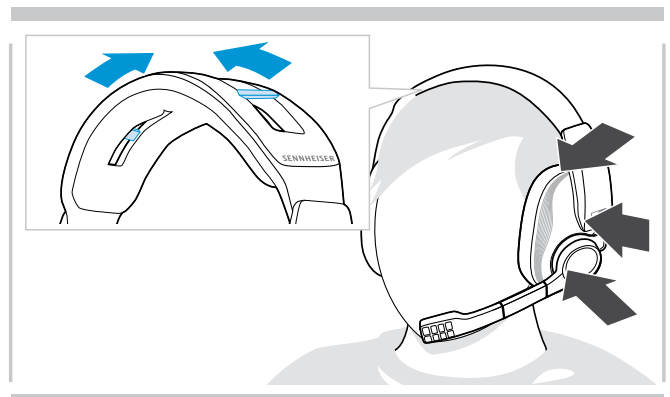

- up to increase the pressure on the ears

## Using the headset

### Switching the headset on

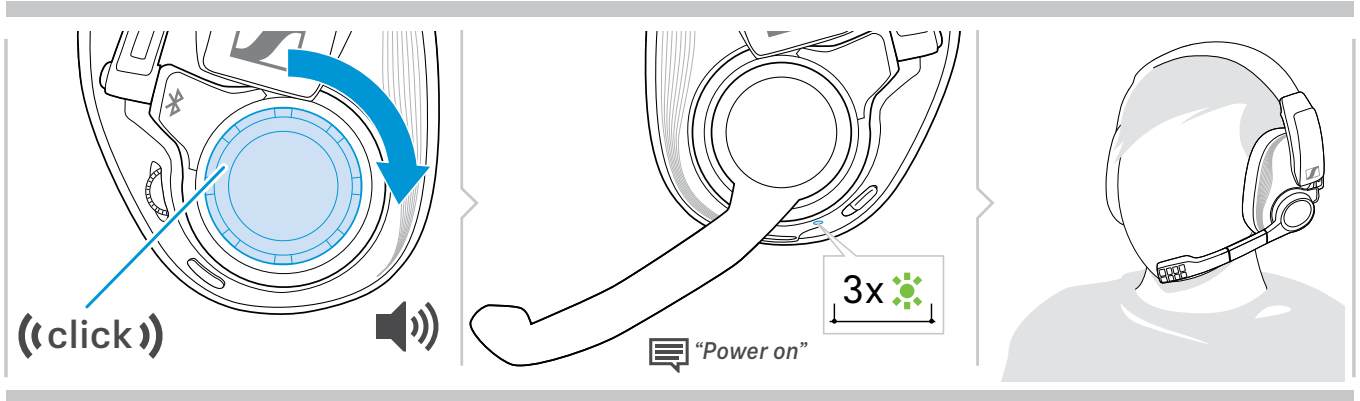

- ▶ Turn the main volume wheel clockwise over a slight resistance. The LED flashes green 3 times. The voice prompt **“power on”** is announced in the headset. If the headset is **not connected via the USB cable**, it automatically tries to establish a connection to wireless devices.

### Establishing a wireless connection (Bluetooth or low latency channel)

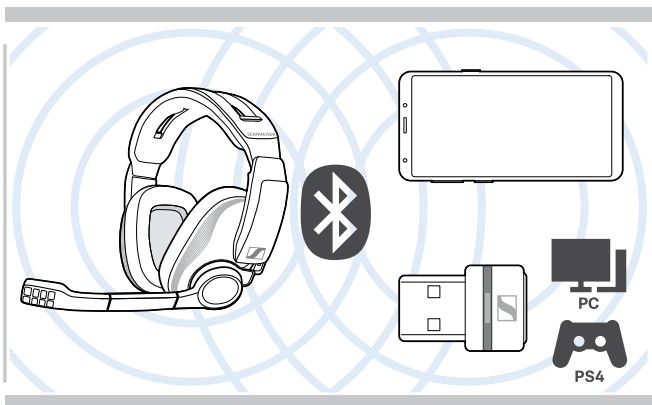

After switch-on, the headset automatically tries to connect to two of the available paired wireless devices.

To connect a third device:

- ▶ Deactivate any active wireless connection to the headset, and enter pairing mode (see page 6 for pairing mode).

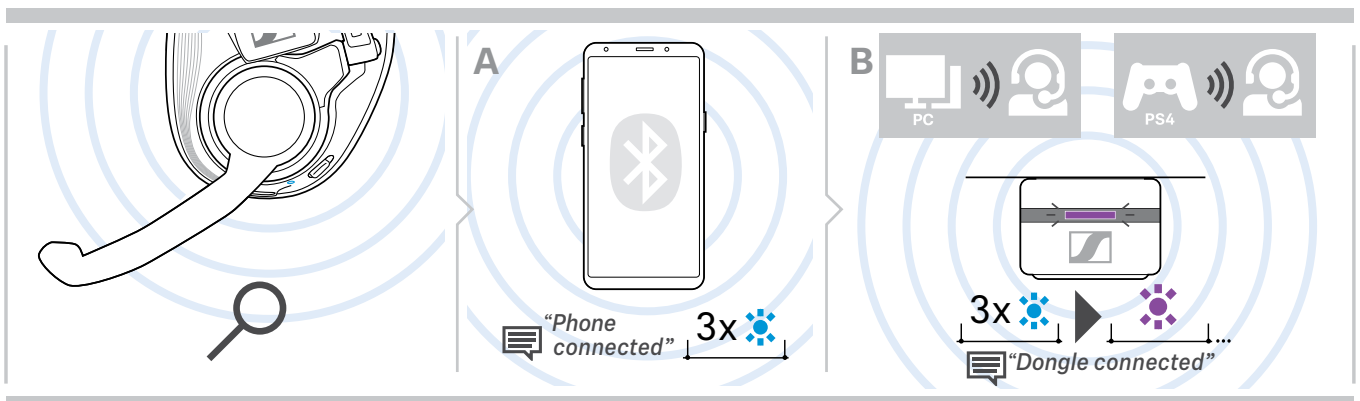

The headset searches paired devices to connect to. Once the connection is successfully established, one or two of the following voice prompts are announced in the headset:

- **“Device connected”** for a smartphone or
- **“Dongle connected”** for the dongle.

If the headset does not find a paired device to connect to, it automatically switches to sleep mode after 15 min.

## Changing the volume



### CAUTION

**Hearing damage due to high volumes!**

Listening at high volume levels for long periods can lead to permanent hearing defects.

- ▷ Set the volume to a low level before putting on the headset.
- ▷ Do not continuously expose yourself to high volumes.

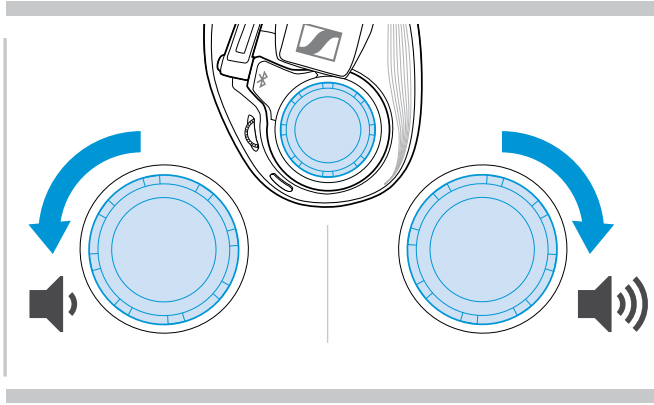

- ▷ Turn the main volume wheel
  - clockwise to increase the volume.
  - counter-clockwise to reduce the volume.

Alternatively you can adjust the volume on your mobile device, PC or PS4™.

### Changing the chat volume separately – headset connected with a PC

If the chat participants are louder or quieter than the gaming sounds during a game, you can change the chat volume. The volume changes for the incoming voices.

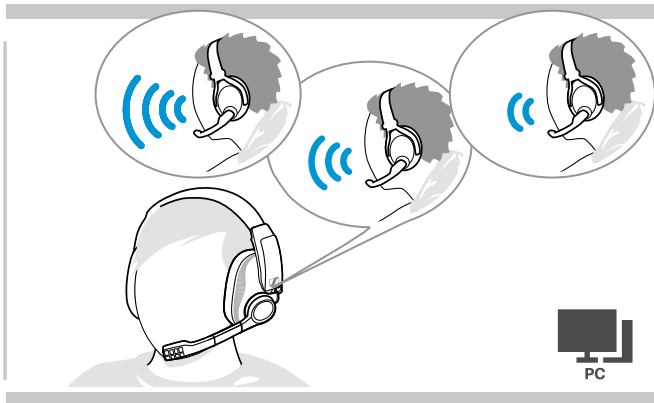

- ▷ Make sure that GSA 70 is set as your default device in Windows: “Sound settings” > “Recording” > “GSA 70 Communication Audio” (see page 9).

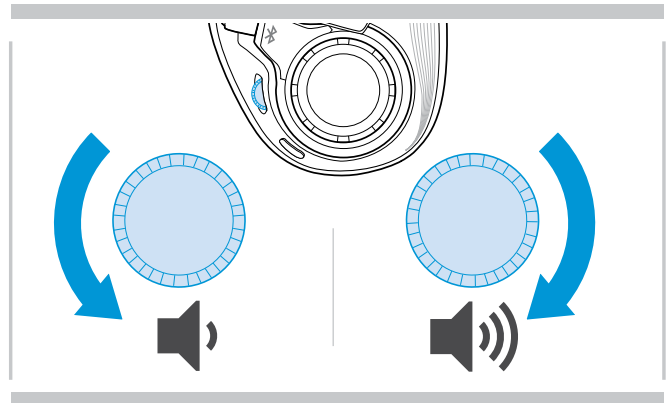

To adjust the chat volume:

- ▷ Turn the chat volume wheel
  - clockwise to increase the volume.
  - counter-clockwise to reduce the volume.

## Muting the headset's microphone

### Muting the microphone

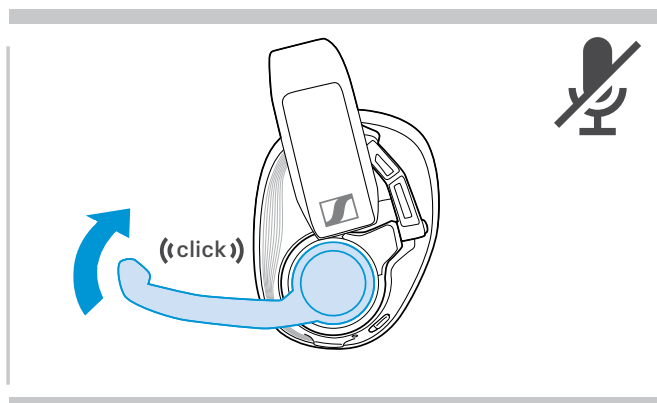

▷ Lift up the boom arm until you hear a click.

### Unmuting the microphone

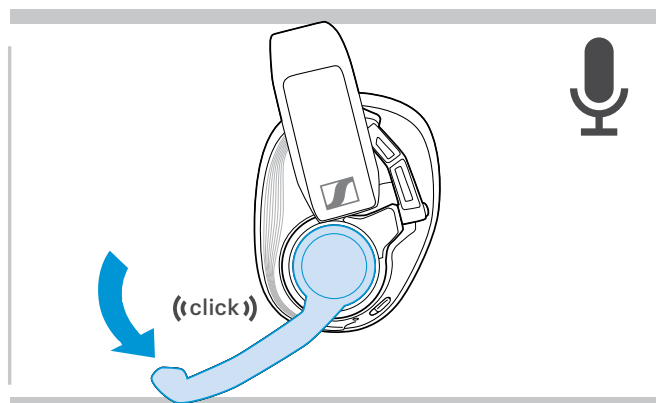

▷ Lift down the boom arm until you hear a click.

## Verifying remaining battery power

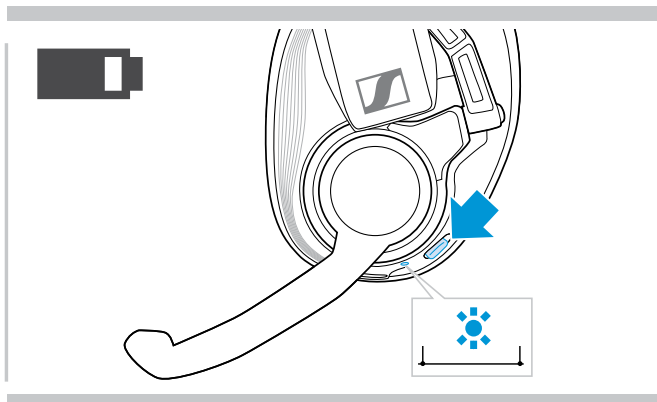

You can retrieve information on the remaining battery power at any time:

▷ Press the Status Slider.

### Information announced

*“More than 80 percent battery left”*

*“More than 60 percent battery left”*

*“More than 40 percent battery left”*

*“More than 20 percent battery left”*

*“Less than 20 percent battery left”*

### Remaining battery power

more than 80%

more than 60%

more than 40%

more than 20%

less than 20%

*„Recharge headset“*



less than 5%; automatic voice prompt

▷ Recharge headset.

## Charging and storing the headset

### Charging the headset

When the battery charge level drops below 5%, the LED flashes red and the voice prompt *“recharge headset”* is announced several times. When the battery is flat, the headset switches off automatically.

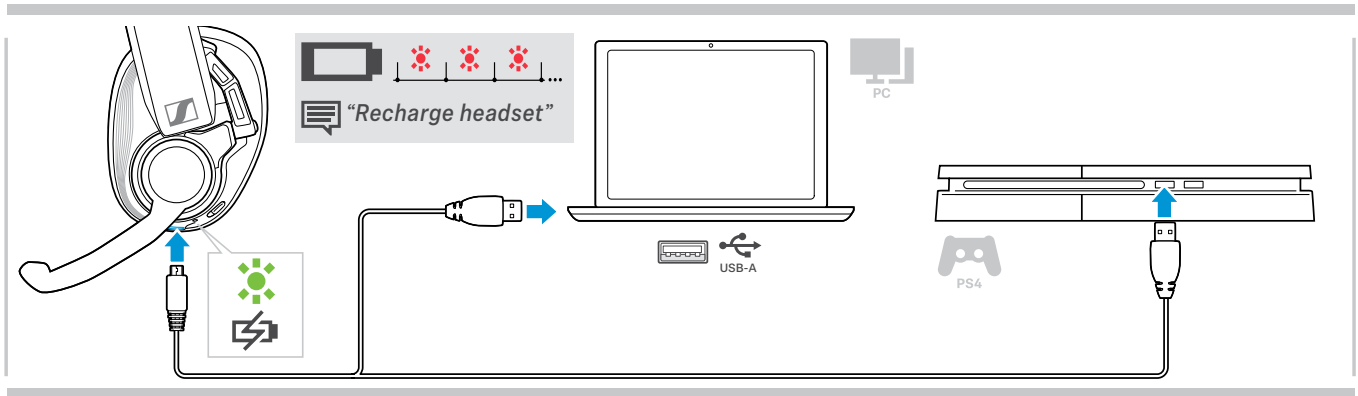

You can charge the headset regardless of the power state (on or off). Wireless connections will keep established.

- ▶ Switch off the headset for faster charging.
- ▶ Connect the USB cable to your headset and your PC or PS4™. The LED lights up green. The battery is being charged.

### Storing the headset

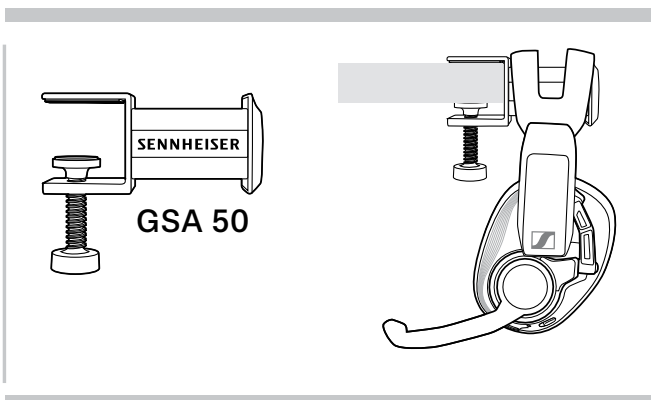

- ▶ Store the headset in a clean and dry environment.

The GSA 50 headset hanger is the perfect accessory for keeping your gaming headset conveniently out of sight, yet easy to reach.

The hanger is available at [www.sennheiser.com](http://www.sennheiser.com)



## Reconnecting wireless devices and waking up the headset from sleep mode

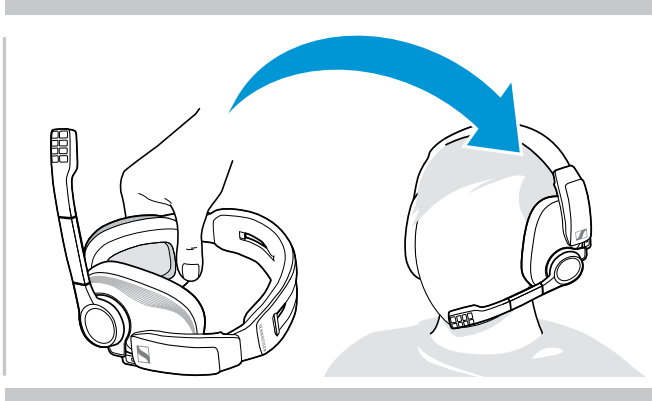

The headset turns to sleep mode to save battery power, if:

- you lay down the headset on your desk (via motion sensor) after 30 minutes **or**
- the headset does not receive any audio signal for 30 minutes **or**
- the headset does not find a paired device to connect to for 15 minutes

To wake up the headset:

- ▶ Put the headset on or press any button. A sensor recognizes the motion. The LED flashes green 3 times. The voice prompt **“power on”** is announced in the headset. The headset re-establishes the wireless connection.

## Switching the headset off

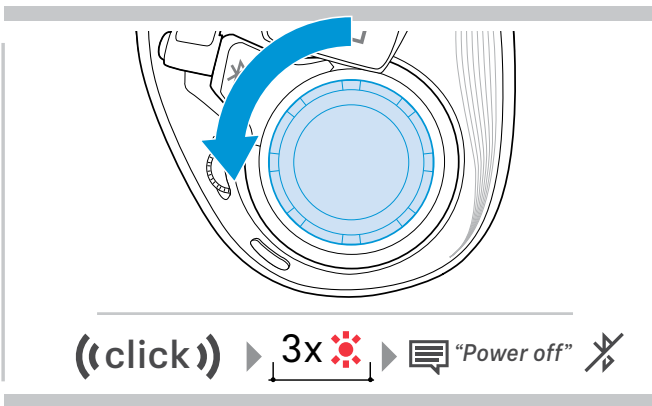

- ▶ Turn the main volume wheel counter-clockwise over a slight resistance. The LED flashes purple 3 times, red 3 times and turns off. The voice prompt **“power off”** is announced in the headset.

## Using and changing settings for the smart button

You can change the configuration of the smart button via the Sennheiser Gaming Suite. As standard setting the smart button switches between equalizer presets. For more information, visit [www.sennheiser.com/GSP670](http://www.sennheiser.com/GSP670).

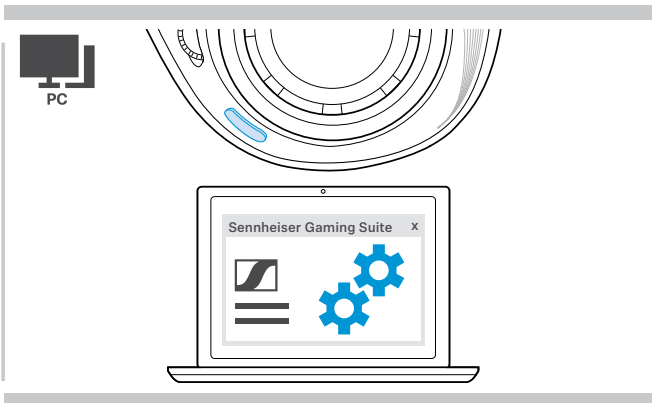

- ▶ Connect the headset to your PC (see page 5) and make sure that the Sennheiser Gaming Suite is installed (see page 9).
- ▶ Change and save the settings for the smart button via the software.

## Maintaining and updating the products

### CAUTION

Liquids can damage the electronics of the product!

Liquids entering the housing of the device can cause a short circuit and damage the electronics.

- ▷ Keep all liquids far away from the product.
- ▷ Do not use any cleansing agents or solvents.

- ▷ Only use a dry cloth to clean the product.

### Replacing the ear pads

For hygienic reasons, you should replace the ear pads from time to time. Spare ear pads are available from your Sennheiser partner.

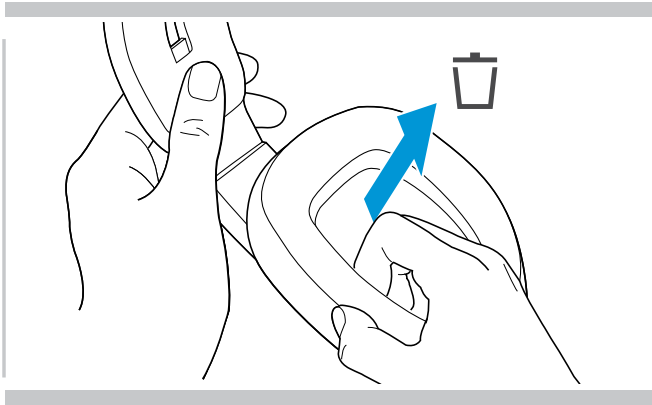

- ▷ Carefully remove the old ear pad from the ear cup.

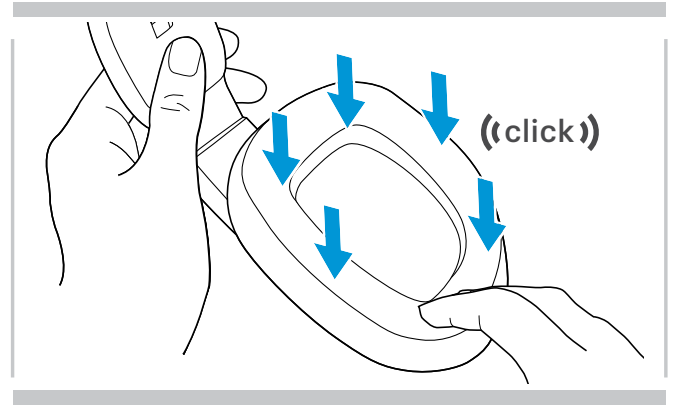

- ▷ Attach the new ear pad to the ear cup by pressing firmly around the ear pad.

### Exchange cover plates

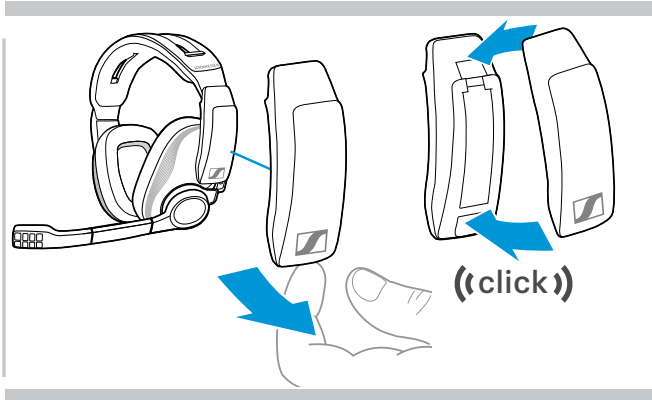

- ▷ Slide a fingernail into the small notch under the cover plate and push it away from the headset.
- ▷ Place the new cover plate on top of the holder and press it down at the bottom.

## Updating the firmware of the products

You can update the firmware of your headset and dongle by using the free [Sennheiser Gaming Suite](#) software (see page 9).

### Updating the firmware of the headset

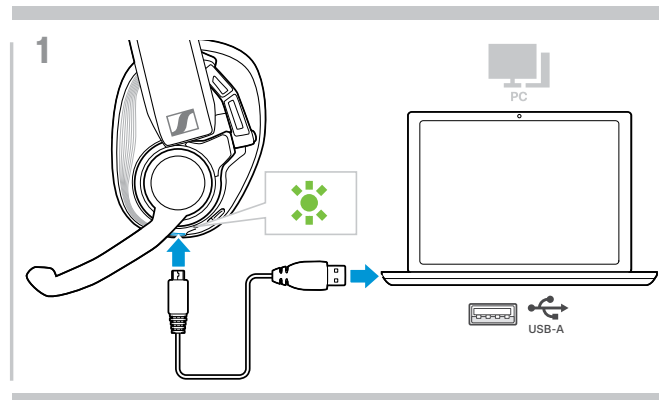

- ▶ Connect the USB cable to your headset and your PC. The LED lights up green.



### Updating the firmware of the dongle

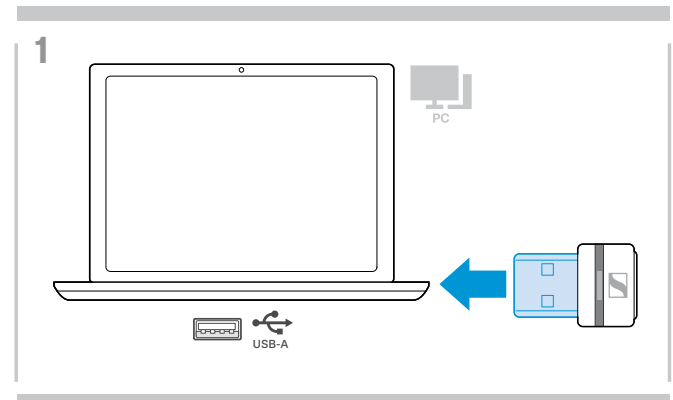

- ▶ Plug the dongle into the USB port of your PC. The LED flashes blue.
- ▶ Start the software. If there is a new software or firmware available the Gaming Suite will guide you through the process.

## Replacing/removing the headset's rechargeable battery

The rechargeable battery must only be replaced or removed by an authorized Sennheiser service center.

- ▶ Contact your Sennheiser service center if the rechargeable battery needs to be replaced. To find a Sennheiser service partner in your country, visit [www.sennheiser.com](http://www.sennheiser.com).

## Clearing the pairing list of the headset (Reset)

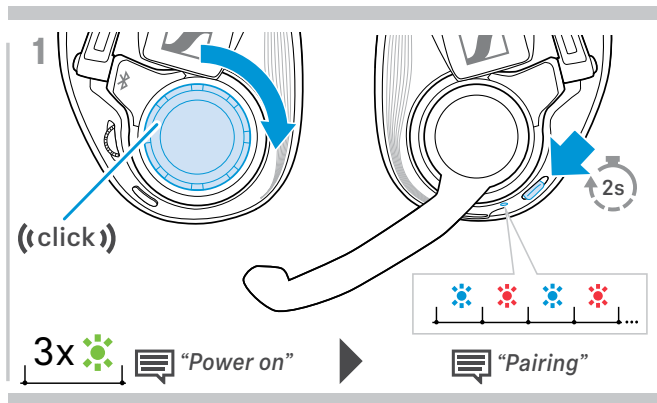

- ▶ Turn the main volume wheel over a slight resistance to turn the headset on.
- ▶ Slide and hold the Pairing Slider until the LED alternately flashes blue and red. The headset is in pairing mode.

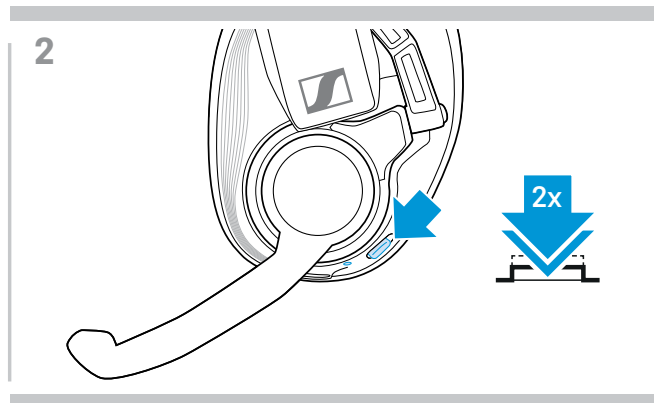

- ▶ Double press the Slider 2 times quickly. The LED flashes purple three times. The pairing list is cleared. The headset tries to pair with wireless devices (see page 6).

## Clearing the pairing list of the dongle (Reset)

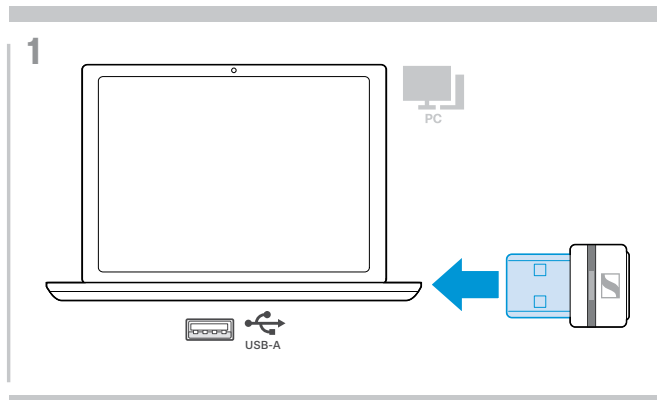

- ▶ Plug the dongle into the USB port of your PC.

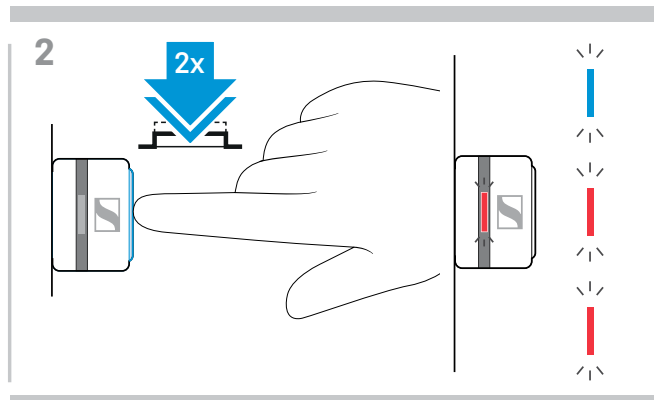

- ▶ Double press the dongle's button. The LED flashes two times red and one time blue. The pairing list is cleared. The dongle tries to pair with wireless devices (see page 6).

# Specifications

## GSP 670 headset

Dimensions (W x H x D)	200 x 90 x 190 mm / 7.9 x 3.5 x 7.5 in
Weight	399 g / 0.88 lbs / 14.07 oz
Connector	USB A to Micro USB
Standby time	Streaming/Music: up to 16 hours Sleep mode: up to 200 hours
Talk time via Bluetooth	up to 20 hours
Charging time	approx. 1.2 h @ 5 V, 430 mA
Rechargeable battery (built-in)	Lithium Polymer / 3.7 V / 335 mA
Max. charging voltage	5.1 V / max. current 470 mA
Speaker principle	dynamic, closed
Frequency response	Microphone: 10 Hz – 7,300 Hz Speakers: 10 Hz – 23,000 Hz
Sound pressure	max. 112 dB
Total harmonic distortion (THD)	< 0,07 %
Microphone type	Bi-Directional ECM
Impedance	28 Ω
Microphone Pick-up pattern	Noise Cancellation
Microphone Sensitivity	-47 dBV/Pa



Bluetooth	version 5.0 / class 1
Range	up to 20 m / 65.6 ft
Transmission frequency	2402 – 2480 MHz
Profiles	<ul style="list-style-type: none"> <li>• HSP Headset Profile (version 1.2)</li> <li>• HFP Handsfree Profile (version 1.7)</li> <li>• A2DP Advanced Audio Distribution Profile (version 1.3)</li> </ul>
Output power	max. 10 dBm (EIRP)

## GSA 70 dongle

Dimensions (W x H x D)	22 x 16 x 6 mm / 0.87 x 0.63 x 0.24 in
Weight	2 g / 0.07 oz / 0.004 lbs
Connector	USB-A plug
Range	up to 10 m / 32.8 ft
Transmission frequency	2402 – 2480 MHz
Output power	max. 8 dBm (EIRP)

## Headset | Dongle

Temperature range	0 °C to +40 °C / +32 °F to +104 °F
Relative humidity	10~80%

## Trademarks

The Bluetooth® word mark and logos are registered trademarks owned by Bluetooth SIG, Inc. and any use of such marks by Sennheiser Communications A/S is under license.

“PlayStation” is a registered trademark or trademark of Sony Interactive Entertainment Inc. also “PS4” is a trademark of the same company.



SENNHEISER

