

# ViewSonic®



---

## **IFP6560/IFP7560 Commercial Touch Display User Guide**

---

**IMPORTANT:** Please read this User Guide to obtain important information on installing and using your product in a safe manner, as well as registering your product for future service. Warranty information contained in this User Guide will describe your limited coverage from ViewSonic Corporation, which is also found on our web site at <http://www.viewsonic.com> in English, or in specific languages using the Regional selection box in the upper right corner of our website. "Antes de operar su equipo lea cuidadosamente las instrucciones en este manual"

---

**Model No. VS17302/ VS17303**

## Thank you for choosing ViewSonic

As a world leading provider of visual solutions, ViewSonic is dedicated to exceeding the world's expectations for technological evolution, innovation, and simplicity. At ViewSonic, we believe that our products have the potential to make a positive impact in the world, and we are confident that the ViewSonic product you have chosen will serve you well.

Once again, thank you for choosing ViewSonic !



# Compliance Information

**NOTE:** This section addresses all connected requirements and statements regarding regulations. Confirmed corresponding applications shall refer to nameplate labels and relevant markings on unit.

## FCC Compliance Statement

This device complies with part 15 of FCC Rules. Operation is subject to the following two conditions: (1) this device may not cause harmful interference, and (2) this device must accept any interference received, including interference that may cause undesired operation.

This equipment has been tested and found to comply with the limits for a Class B digital device, pursuant to part 15 of the FCC Rules. These limits are designed to provide reasonable protection against harmful interference in a residential installation. This equipment generates, uses, and can radiate radio frequency energy, and if not installed and used in accordance with the instructions, may cause harmful interference to radio communications. However, there is no guarantee that interference will not occur in a particular installation. If this equipment does cause harmful interference to radio or television reception, which can be determined by turning the equipment off and on, the user is encouraged to try to correct the interference by one or more of the following measures:

- Reorient or relocate the receiving antenna.
- Increase the separation between the equipment and receiver.
- Connect the equipment into an outlet on a circuit different from that to which the receiver is connected.
- Consult the dealer or an experienced radio/TV technician for help.

**Warning:** You are cautioned that changes or modifications not expressly approved by the party responsible for compliance could void your authority to operate the equipment.

## Industry Canada Statement

CAN ICES-3 (B)/NMB-3(B)

Contains FCC ID:

IC ID:

## CE Conformity for European Countries

 The device complies with the EMC Directive 2014/30/EU and Low Voltage Directive 2014/35/EU.

### Following information is only for EU-member states:

The mark shown to the right is in compliance with the Waste Electrical and Electronic Equipment Directive 2012/19/EU (WEEE). The mark indicates the requirement NOT to dispose the equipment as unsorted municipal waste, but use the return and collection systems according to local law.



## Indian Restriction of Hazardous Substances

Restriction on Hazardous Substances statement (India) This product complies with the “India E-waste Rule 2011” and prohibits use of lead, mercury, hexavalent chromium, polybrominated biphenyls or polybrominated diphenyl ethers in concentrations exceeding 0.1 weight % and 0.01 weight % for cadmium, except for the exemptions set in Schedule 2 of the Rule.

## Declaration of RoHS2 Compliance

This product has been designed and manufactured in compliance with Directive 2011/65/EU of the European Parliament and the Council on restriction of the use of certain hazardous substances in electrical and electronic equipment (RoHS2 Directive) and is deemed to comply with the maximum concentration values issued by the European Technical Adaptation Committee (TAC) as shown below:

Substance	Proposed Maximum Concentration	Actual Concentration
Lead (Pb)	0.1%	< 0.1%
Mercury (Hg)	0.1%	< 0.1%
Cadmium (Cd)	0.01%	< 0.01%
Hexavalent Chromium (Cr <sup>6+</sup> )	0.1%	< 0.1%
Polybrominated biphenyls (PBB)	0.1%	< 0.1%
Polybrominated diphenyl ethers (PBDE)	0.1%	< 0.1%
Bis (2-ethylhexyl) phthalate (DEHP)	0.1%	< 0.1%
Butyl benzyl phthalate (BBP)	0.1%	< 0.1%
Dibutyl phthalate (DBP)	0.1%	< 0.1%
Diisobutyl phthalate (DIBP )	0.1%	< 0.1%

Certain components of products as stated above are exempted under the Annex III of the RoHS2 Directives as noted below:

Examples of exempted components are:

1. Mercury in cold cathode fluorescent lamps and external electrode fluorescent lamps (CCFL and EEFL) for special purposes not exceeding (per lamp):
  - (1) Short length ( $\leq 500$  mm): maximum 3.5 mg per lamp.
  - (2) Medium length ( $> 500$  mm and  $\leq 1,500$  mm): maximum 5 mg per lamp.
  - (3) Long length ( $> 1,500$  mm): maximum 13 mg per lamp.
2. Lead in glass of cathode ray tubes.
3. Lead in glass of fluorescent tubes not exceeding 0.2% by weight.
4. Lead as an alloying element in aluminium containing up to 0.4% lead by weight.
5. Copper alloy containing up to 4% lead by weight.

6. Lead in high melting temperature type solders (i.e. lead-based alloys containing 85% by weight or more lead).
7. Electrical and electronic components containing lead in a glass or ceramic other than dielectric ceramic in capacitors, e.g. piezoelectronic devices, or in a glass or ceramic matrix compound.

## Cautions and Warnings

1. Read these instructions completely before using the equipment.
2. Keep these instructions in a safe place.
3. Heed all warnings and follow all instructions.
4. Always handle the LCD display with care when moving it.
5. Never remove the rear cover. This LCD display contains high-voltage parts. You may be seriously injured if you touch them.
6. Do not use this equipment near water. **Warning:** To reduce the risk of fire or electric shock, do not expose this apparatus to rain or moisture.
7. Avoid exposing the LCD display to direct sunlight or another heat source. Orient the LCD display away from direct sunlight to reduce glare.
8. Clean with a soft, dry cloth. If further cleaning is required, see the “Care and Maintenance” section in this guide for further instructions.
9. Do not block any ventilation openings. Install the equipment in accordance with the manufacturer’s instructions.
10. Do not install near any heat sources such as radiators, heat registers, stoves, or other devices (including amplifiers) that produce heat.
11. Place the LCD display in a well ventilated area. Do not place anything on the LCD display that prevents heat dissipation.
12. Do not place heavy objects on the LCD display, video cable, or power cord.
13. If smoke, an abnormal noise, or a strange odor is present, immediately switch the LCD display off and call your dealer or ViewSonic. It is dangerous to continue using the LCD display.
14. Do not attempt to circumvent the safety provisions of the polarized or grounding-type plug. A polarized plug has two blades with one wider than the other. A grounding type plug has two blades and a third grounding prong. The wide blade and the third prong are provided for your safety. If the plug does not fit into your outlet, consult an electrician for replacement of the outlet.
15. Protect the power cord from being tread upon or pinched, particularly at the plug, and the point where it emerges from the equipment. Be sure that the power outlet is located near the equipment so that it is easily accessible.

(Continued on next page)

**16.** Only use attachments/accessories specified by the manufacturer.

**17.** Use only with the cart, stand, tripod, bracket, or table specified by the manufacturer, or sold with the equipment. When a cart is used, use caution when moving the cart/equipment combination to avoid injury from tipping over.



**18.** Unplug this equipment when it will be unused for long periods of time.

**19.** Refer all servicing to qualified service personnel. Service is required when the unit has been damaged in any way, such as: if the power-supply cord or plug is damaged, if liquid is spilled onto or objects fall into the unit, if the unit is exposed to rain or moisture, or if the unit does not operate normally or has been dropped.

**20.** The Unit is a Monitor with LED backlight intended for general office used.

# Contents

## Compliance Information

FCC Compliance Statement.....	i
Industry Canada Statement.....	i
CE Conformity for European Countries.....	i
Indian Restriction of Hazardous Substances .....	ii
Declaration of RoHS2 Compliance.....	ii
Cautions and Warnings .....	iii

## Copyright Information

For Your Records .....	1
------------------------	---

## 1. Getting Started

1.1 Package Contents .....	2
1.2 Wall Mount Kit Specifications (VESA).....	3

## 2. ViewBoard Features

2.1 Control Panel Overview.....	5
2.2 Terminal Interface Overview .....	8
2.3 Remote Control Overview .....	9
2.4 Inserting Remote Control Batteries .....	10
2.5 Remote Control Receiver Range .....	11

## 3. Set Up Your Display

3.1 Connecting an External Device.....	12
3.2 RS232 Connections .....	14
3.3 Connect a USB, HDMI or Media devices .....	15
3.4 Video and Audio out connection.....	16

## 4. ViewBoard Basic Operation

4.1 ViewBoard Launcher screen .....	19
4.2 Tool Bar.....	21
4.3 ViewBoard OSD (On Screen Display) Menu.....	24

## 5. ViewBoard Embedded Application and Setting

5.1 vBoard.....	53
5.2 ViewBoard Cast.....	58
5.3 Other default apps.....	61

## **6. Trouble Shooting**

## **7. Care and Maintenance**

## **8. Display Modes**

8.1 VGA.....	68
8.2 HDMI1/2/3/OPS/SDM.....	69
8.3 DP .....	70

## **9. Specifications**

## **10. RS-232 Protocol**

10.1 Introduction.....	72
10.2 Description .....	72
10.3 Protocol .....	74

## **Warranty Statement**

Limited Warranty .....	89
Mexico Limited Warranty .....	91



# Copyright Information

Copyright © ViewSonic Corporation, 2020. All rights reserved.

Macbook, Macbook Pro, Mac OS, iOS are registered trademarks of Apple Inc.

Microsoft, Windows, and the Windows logo are registered trademarks of Microsoft Corporation in the United States and other countries.

ViewSonic, the three birds logo, OnView, ViewMatch, and ViewMeter are registered trademarks of ViewSonic Corporation.

VESA is a registered trademark of the Video Electronics Standards Association.

DPMS, DisplayPort, and DDC are trademarks of VESA.

Disclaimer: ViewSonic Corporation shall not be liable for technical or editorial errors or omissions contained herein; nor for incidental or consequential damages resulting from furnishing this material, or the performance or use of this product.

In the interest of continuing product improvement, ViewSonic Corporation reserves the right to change product specifications without notice. Information in this document may change without notice.

No part of this document may be copied, reproduced, or transmitted by any means, for any purpose without prior written permission from ViewSonic Corporation.

## For Your Records

<b>Product Name:</b>	IFP6560/IFP7560 ViewSonic Commercial Touch Display
<b>Model Number:</b>	VS17302/VS17303
<b>Document Number:</b>	IFP6560/IFP7560_UG_ENG Rev. 1B 02-04-20
<b>Serial Number:</b>	_____
<b>Purchase Date:</b>	_____

### Product disposal at end of product life

ViewSonic respects the environment and is committed to working and living green. Thank you for being part of Smarter, Greener Computing.

Please visit ViewSonic website to learn more.

USA & Canada: <http://www.viewsonic.com/company/green/recycle-program/>

Europe: <http://www.viewsoniceurope.com/eu/support/call-desk/>

Taiwan: <https://recycle.epa.gov.tw/>

# 1. Getting Started

Congratulations on your purchase of a ViewBoard

**Important!** Save the original box and all packing material for future shipping needs.

**Note:** The word “Windows” in this user guide refers to Microsoft Windows operating system.

## 1.1 Package Contents

- HDMI cable
- Power cable x 4
- Remote control
- AAA battery x 2
- USB cable
- Stylus pen x 2
- Quick start guide
- Plate
- Screw x 9

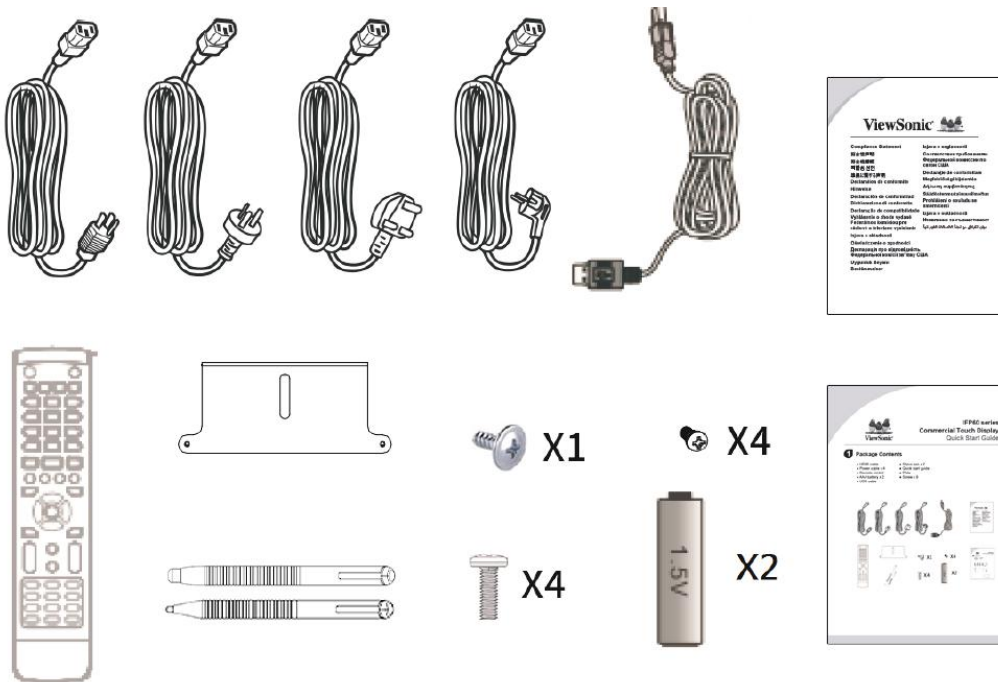

## 1.2 Wall Mount Kit Specifications (VESA)

To obtain a wall-mounting kit or height adjustment base, contact ViewSonic® or your local dealer. Refer to the instructions that come with the base mounting kit. Do the following for wall mount installation.

1. Verify that the display power was turned off, and then disconnect the power cord.
2. Remove touch pans from the front bezel of display. Lay the display face down on a towel or blanket. Making sure the surface of panel won't be damaged when lay the display down.
3. To fix wall mount braces (or holder) on the back cover using screws of the appropriate length. (Screws removal might be required.)
4. To find and identify a VESA mount bracket which compatible with display VESA mount holder. To fix the bracket on a wall which made by cement or metal. Attach the display on the wall mount bracket and make sure it's solid.

### IFP6560

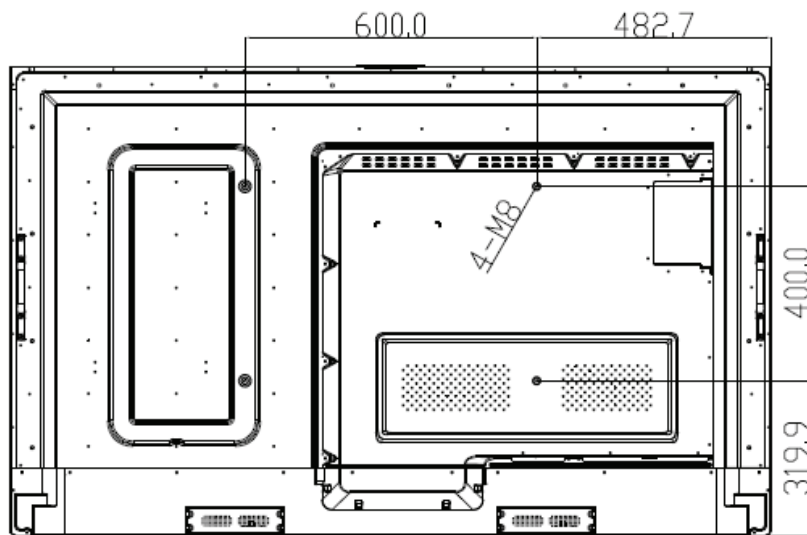

### IFP7560

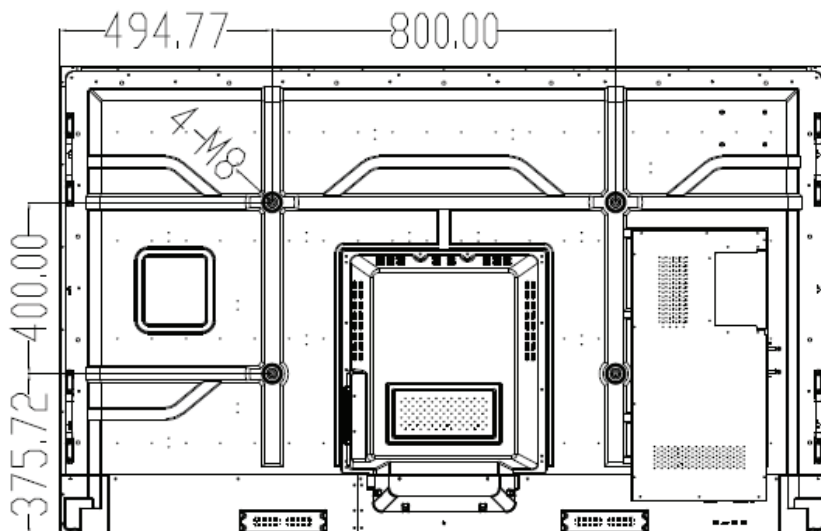

- ViewSonic provides the standard dimensions for wall mount kits as shown in the table below.

Model	VESA Spec.	Screw	Quantity
IFP6560	600x400mm	M8x18mm	4
IFP7560	800x400mm	M8x18mm	4

*NOTE: For use only with UL Listed Wall Mount Bracket with minimum weight/load: 80kg*

- To find the perfect mount, please browse [www.viewsonic.com](http://www.viewsonic.com) or call our service team.
- When purchasing our wall mount kit, a detailed install manual and all parts necessary for assembly were provided.
- Do not use the screws that longer than the standard dimension, as they may cause damage to the inside of the LCD display set.

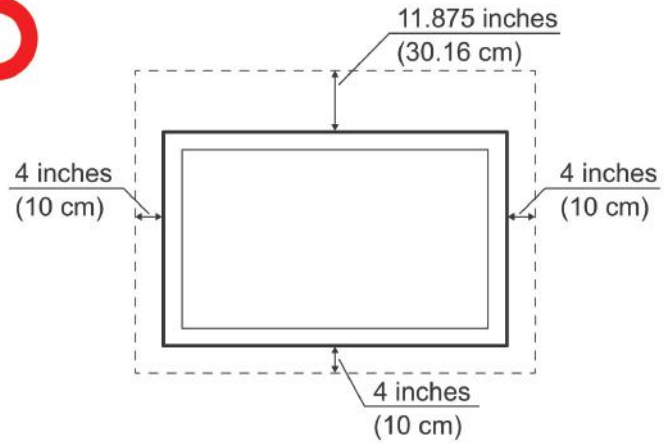
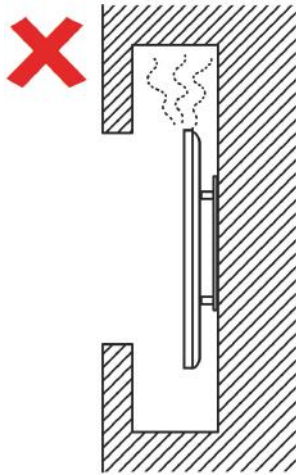

## 2. ViewBoard Features

This section is mention about the features of interface and keypad on IFP6560 and IFP7560.

**Note:** The features or applications described in this user’s manual may vary depending on the purchased model.

### 2.1 Control Panel Overview

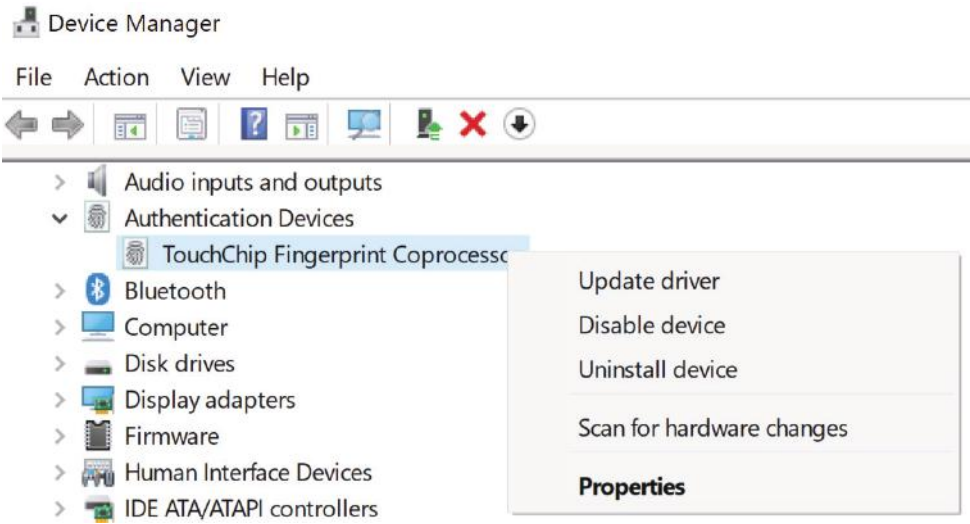

Item	Description
1	Home button: Back to Embedded player home page.
2	Menu: Bring up setting menu.
3	Volume down: Decrease volume
4	Volume up: Increase volume
5	Front USB 2.0 *2 Those two USB ports support auto switch function. When switch to a new channel from currently, USB port will direct to the new channel. <b>Note:</b> You may need to connect the USB touch to your external PC from front/rear touch port.
6	HDMI 1(ver.1.4) support resolution up to 3840x2160 30Hz.
7	Touch USB for HDMI1
8	3.5mm MIC in

<p>9</p>	<p>Power key:</p> <p>LED indicator states</p> <p>RED: Standby mode. Press the power button to power up ViewBoard.</p> <p>BLUE: Device is in operation. Press and hold the power button to turn off ViewBoard.</p> <p>RED/BLUE blinking: ViewBaord is in operation but panel is off. Press power button to wake up panel.</p> <p>Power On: Press power button. LED will turn to blue from red.</p> <p>Power Off: Press and hold power button for 5s. LED will turn to red from blue.</p> <p>Panel backlight Off: Press power button shortly. Power LED will blink in blue/red.</p>
<p>10</p>	<p>Ambient light sensor / Remote control IR receiver.</p> <p>IFP6560/IFP6570 support Intelligent Eye Protection. When you turn on the feature, panel backlight will be adjusted according to the ambient light.</p> <p>Please do not cover ambient light sensor and IR receiver to avoid the features malfunction.</p>
<p>11</p>	<p>Fingerprint sensor</p> <p>The sensor to provide the most secure for biometrics sign-in.</p> <p>It is able to apply on Windows Hello or MyViewBoard – a Digital cloud Whiteboard designed by ViewSonic.</p> <p>Since Windows Hello is requiring the driver framework by WBF, if you can't see the fingerprint sign-in option in Windows control panel, you may need to remove and delete fingerprint driver from Windows Device Manager and reinstall driver by Windows update.</p> <p>[Remove and delete driver from Windows Device Manager]</p>  <p>The screenshot shows the Windows Device Manager window. The 'Authentication Devices' category is expanded, and 'TouchChip Fingerprint Coprocessor' is selected. A context menu is open over the device, showing options: 'Update driver', 'Disable device', 'Uninstall device', 'Scan for hardware changes', and 'Properties'.</p>

11

[Press  , right click on “Biometric Coprocessor” > Update driver > Search automatically for updated software, internet connection is required]

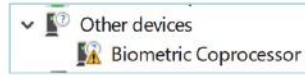

## 2.2 Terminal Interface Overview



Item	Description
1	DP in: DisplayPort (1.2ver). Support resolution up to 3840x2160 60Hz.
2	HDMI 1.4/2.0 in: Resolution support up to 3840x2160 60Hz.
3	Touch USB: Touch USB connection for HDMI2/3, DP, and VGA
4	USB 3.0: For embedded player.
5	USB 2.0: For embedded player.
6	HDMI Out: Support 2K/4K image output to another monitor. It only provides screen mirroring from IFP6560/IFP7560.
7	SDM: An optional PC module for IFP7560
8	OPS: The Open Pluggable Specification PC module slot. The optional PC module, VPC12-WPO series was optimized for IFP60 ViewBoard. Please contact local dealer or visit ViewSonic website for detail information.
9	3.5mm earphone out
10	SPDIF out.
11	RS232: ViewBoard was allowed to control through RS232 device e.g. Remote PC or a console. Please to get more information from the chart of RS-232 Protocol.
12	Ethernet: It supports 10M/100M Ethernet connection by RJ-45 jack. It also supports remote control by LAN when the standby mode set on "Sleep". The control codes are same as RS-232 command code. Please get more information from the chart of RS-232 Protocol.
13	VGA in: Support resolution up to 1920x1080.
14	3.5mm Audio in jack for VGA.

**Note:** For your safety, please turn off ViewBoard and remove power cord before install/uninstall OPS or SDM



## 2.3 Remote Control Overview



- 1 Power on/off
- 2 Input Source selection
- 3 Image adjustment menu for DP/HDMI/VGA
- 4 Audio adjustment menu for DP/HDMI/VGA
- 5 Numbers keypad
- 6 Adjust aspect ratio for DP/HDMI/VGA
- 7 Volume +/- 1
- 8 Display sleep countdown
- 9 Mute
- 10 Brightness +/- 1
- 11 Back to Embedded player Home screen
- 12 Setting menu
- 13 Up/Down/Right/Left/Ok keys
- 14 Channel information
- 15 Return to previous page
- 16 Media control
- 17 F1: Screen capture  
The files would be saved in the embedded player under the path of System files\Screenshots\
- 18 F2: Screen Freeze
- 19 Power on/off

## 2.4 Inserting Remote Control Batteries

To load the provided batteries into the remote control follow these instructions. We recommend that don't mix old and new batteries together.

1. Remove the batteries cover on the rear of the remote control.
2. Load two "AAA" batteries in to the battery sink. Please make sure the battery polarities are in correct location.
3. Make sure the batteries are installed neat and correctly, after that put the battery cover back and start to use the remote control.

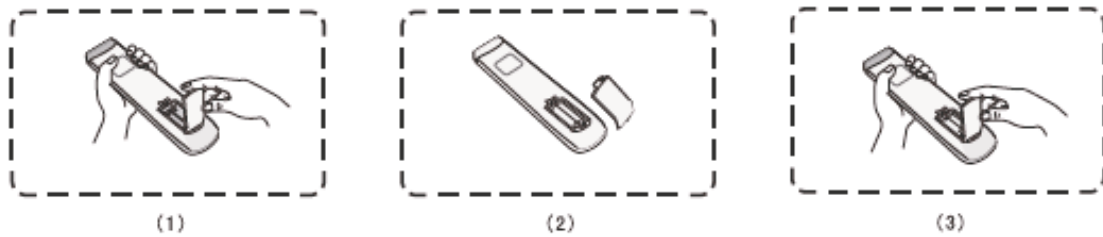

**Warning:** There is a risk of explosion if batteries are replaced with the incorrect type.

**Note:** Always dispose of old batteries in an environmentally friendly way. Contact your local government for more information on how to dispose batteries safely.

## 2.5 Remote Control Receiver Range

The working range of the remote control is 7 meter. Make sure there is no object between remote control and IR receiver. You may need to replace a pair of new battery if the remote control workable range decreases or out of order.

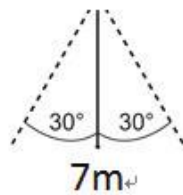

## 3. Set Up Your Display

**Warning:** For the safety of you and your device, please do not connect to a power supply before the external device is prepared.

### 3.1 Connecting an External Device

1. To display video by VGA cable.

- Connect a VGA cable (15-pin) from an external device or PC to the VGA IN port on the ViewBoard.
- Export audio from a PC or media box to audio in by 3.5mm jack.
- Connect a Touch USB cable from PC to display rear Touch USB port.

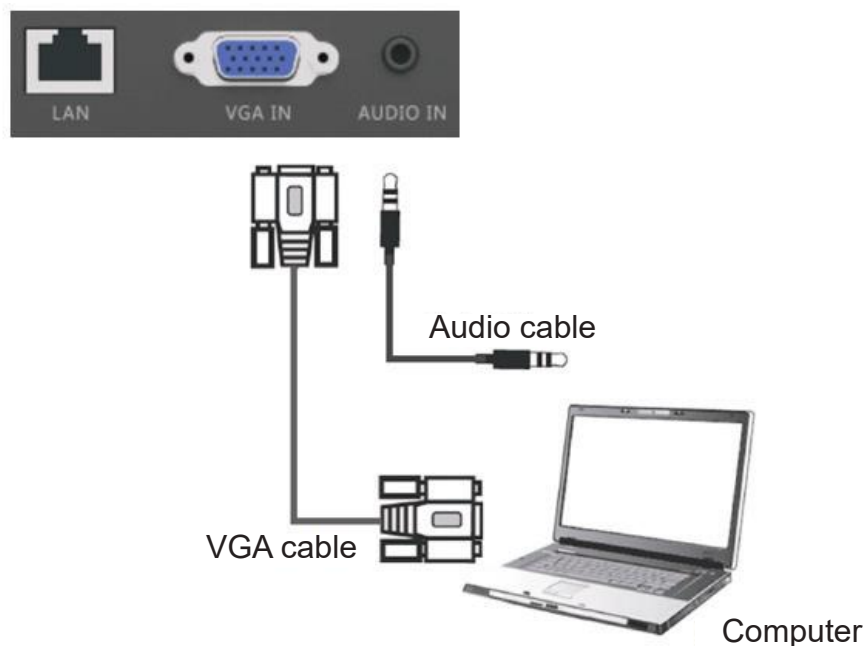

**Note:** Rear Touch USB port is arranged in pair with HDMI2/3, DP and VGA.

2. To display video via HDMI cable.

- Connect a HDMI cable from your player or PC to the HDMI port on ViewBoard.
- Connect a Touch USB cable from PC to ViewBoard Touch port.

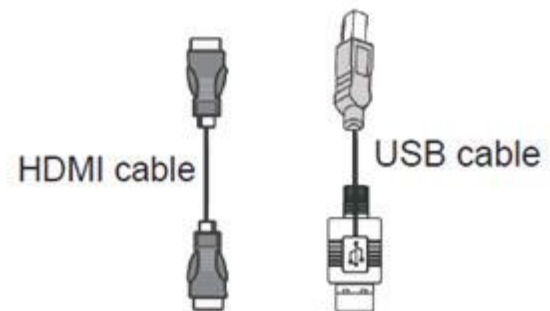

Computer

**Note:**

Front Touch USB port is arranged in pair with HDMI1

Rear Touch USB port is arranged in pair with HDMI2/3, DP and VGA.

## 3.2 RS232 Connections

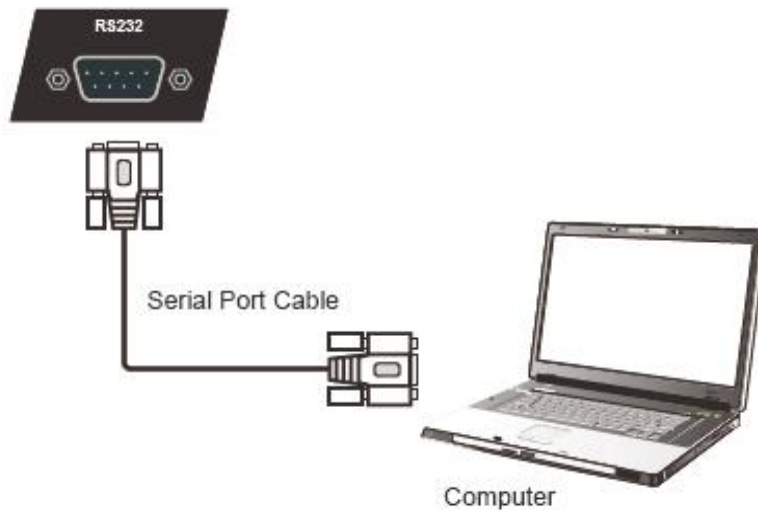

Through RS-232 connection, you could turn on ViewBoard, adjust volume or switch input source from a remote PC or console. ViewSonic also provide an easy-to-use control tool, vController. Please find the introduction and download the SW from ViewSonic website. More information about the remote control connection, please refer the chart of RS-232 Protocol.

<https://www.youtube.com/watch?v=0Jlvw3IMZjM>

### 3.3 Connect a USB, HDMI or Media devices

Just like a regular display, it is easy to connect devices on ViewBoard through USB, HDMI or others.

1. USB: Easy to connect a USB keyboard or mouse without extra settings. ViewBoard also support a regular USB storage sticker (FAT32 format for embed player). 3rd Wi-Fi adaptor is limited supported. Please contact local service center for more information on technically.
2. HDMI: Support high-resolution signal input for Set-Top-Box, Blu-Ray player or 4K PC. HDR function is not supported on IFP60 series.
3. Mic in for loudspeaker: Plug-in a Mic by 3.5mm jack, ViewBoard will be a loudspeaker for meeting or classroom. The feature doesn't support audio recording or conference call due to hardware limitation.

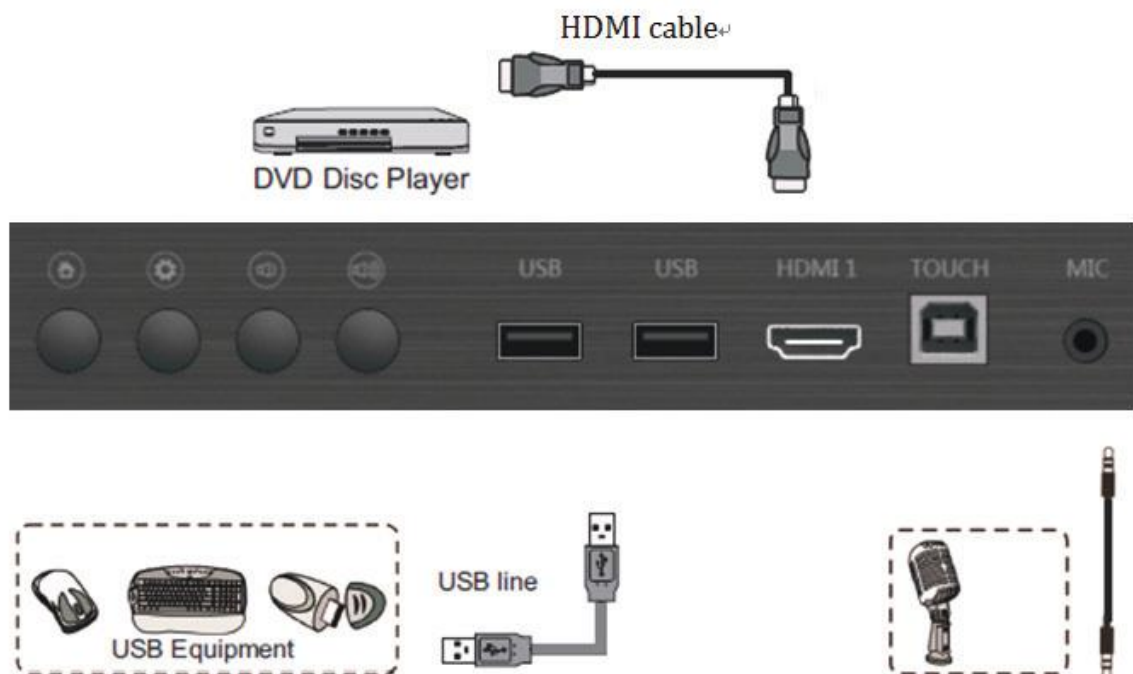

**Note:**

HDMI 1 supports resolution up to 3840x2160 30Hz  
HDMI 2/3 supports resolution up to 3840x2160 60Hz  
DisplayPort supports resolution up to 3840x2160 60Hz

### 3.4 Video and Audio out connection

Through HDMI out, it's able to do screen mirroring with audio to a regular monitor or projector. Export image resolution support 1920 x 1080 (2K) and 3840 x 2160 (4K). You could adjust the settings from settings > display > HDMI out from embed player settings menu.

Through earphone out or SPDIF, you could export audio from ViewBoard to an amplifier or speaker.

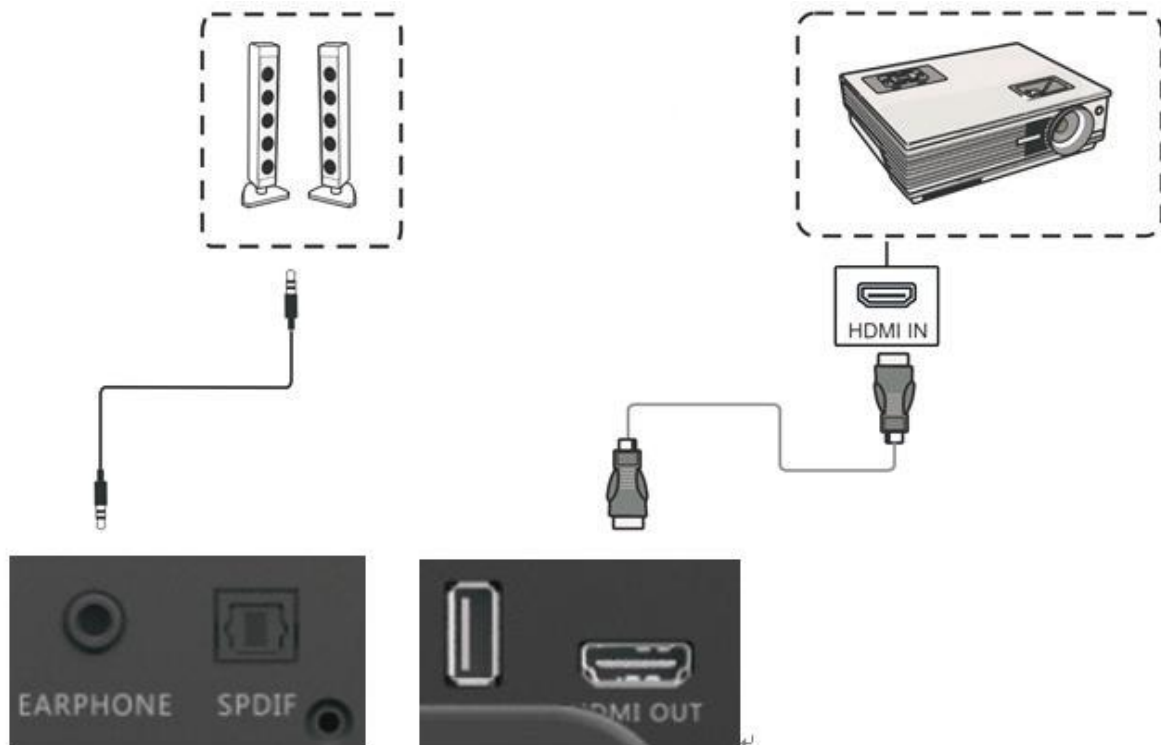



## 4. ViewBoard Basic Operation

### Power on ViewBoard

1. Plug in power cord and turn the AC switch on.
2. Press Power button. Power LED will turn to blue.

IFP6560



IFP7560





Power button

## 4.1 ViewBoard Launcher screen

### Initial setting for Education mode or Corporate mode

ViewBoard will run setup wizard when first power on ViewBoard.

Step 1: Select system language.

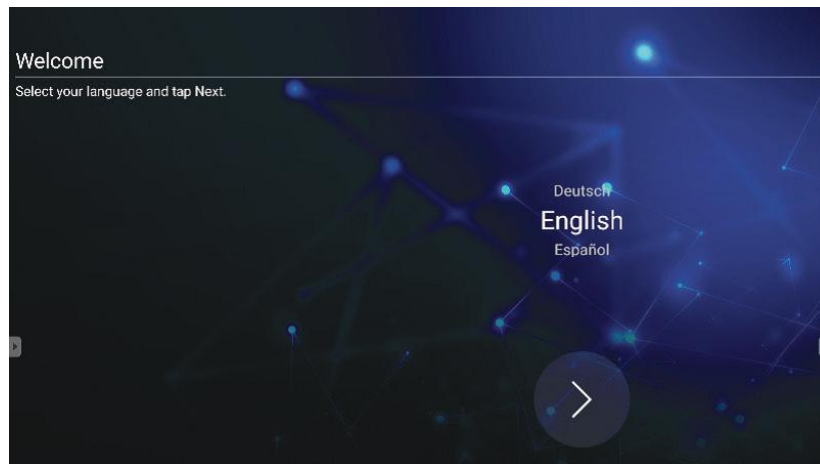

Step 2: Choose Ethernet connection method. DHCP is for regular network connection. Static IP is for a specific network environment.

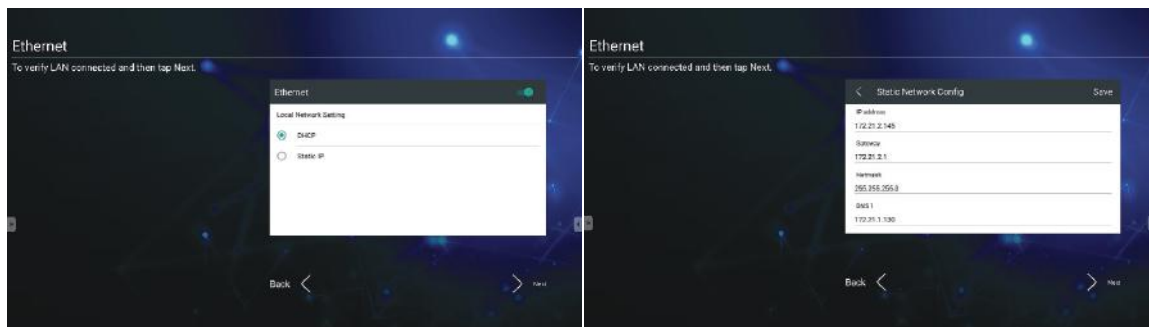

Step 3: ViewBoard is able to obtain the accurate date and time from a standard time server. Select the appropriate time zone for your location.

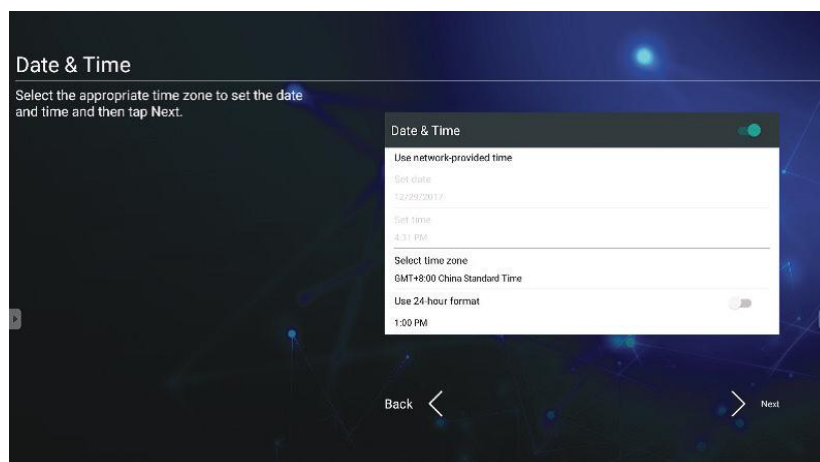

Step 4: Select the preferred launcher theme: vBoard – digital white board or vLauncher mode.

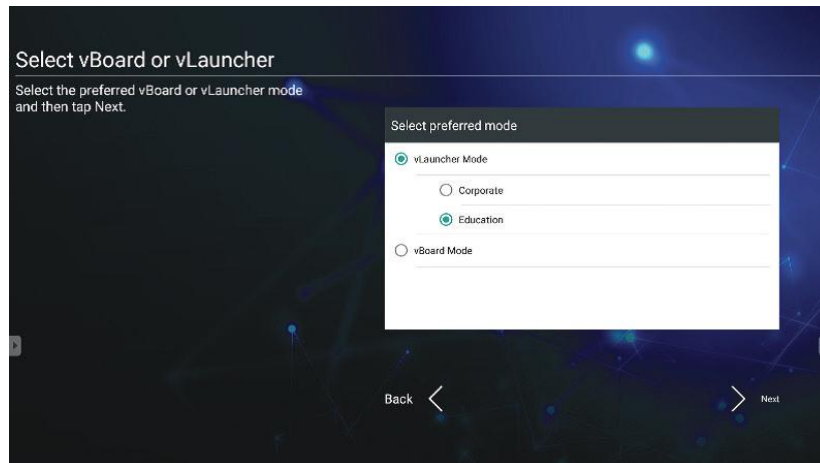







### vLauncher for customized welcome screen



Customizable - choose your "top4" default app

Editable - change your default message

Switchable - change your launcher theme image

Item	Description
 vBoard	Click to vBoard software The icon can be replaced or removed
 ViewBoard Cast	Click to ViewBoard Cast software The icon can be replaced or removed
 Chromium	Click to enter internet page The icon can be replaced or removed
 APPs	Click to enter Embedded Player application management page
 Network	Click to enter Ethernet settings
 USB storage	Click it to open file manager

## How to customize the default app:

Step 1:  
click the "app" icon to go to the app listing page

Step 2:  
long press the preferred app icon  
e.g. WPS and drag to launcher page

Step 3:  
the chosen app e.g. WPS will be  
appeared in the launcher as the  
short-cut to launch the program

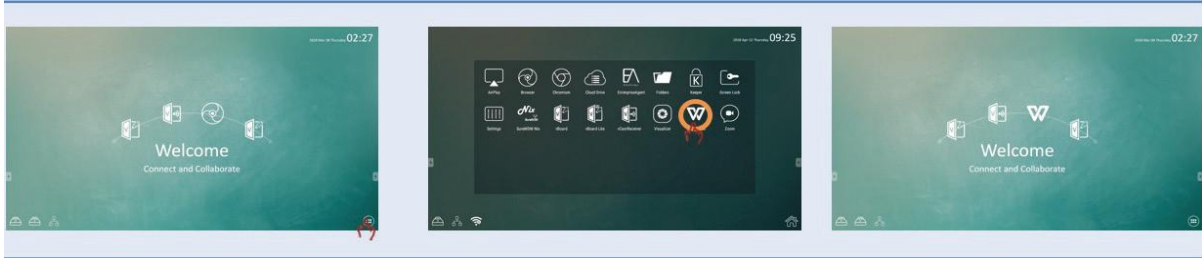

If user swipes the main page from right to left, user will see the 2nd page which include other preloaded app and setting.

More app and setting: More introductions in chapter 5

## 4.2 Tool Bar

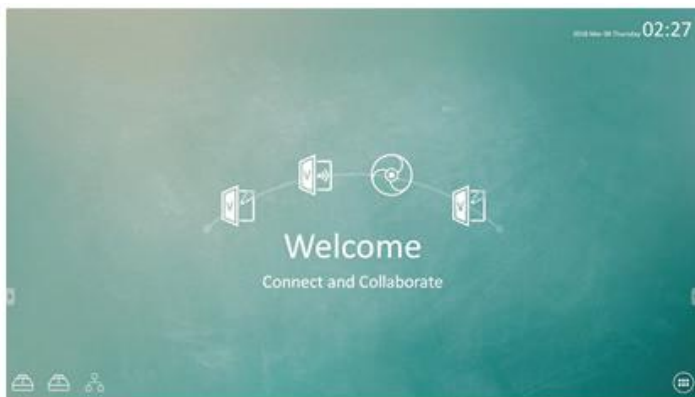

Tool bar trigger icon is in the edge of the ViewBoard

Item	Description
	Extend/Roll back tool bar
	Return previous page
	Back to embedded player Home page
	vBoard
	File Manager
	Annotation tool
	Screen capture: full screen/snipping tool
	Others: magnifier / Spotlight

## File Manager

Browse files

Sort by Document file

Sort by Picture file

Sort by Video file

File on Cloud

File on USB drive

Exit

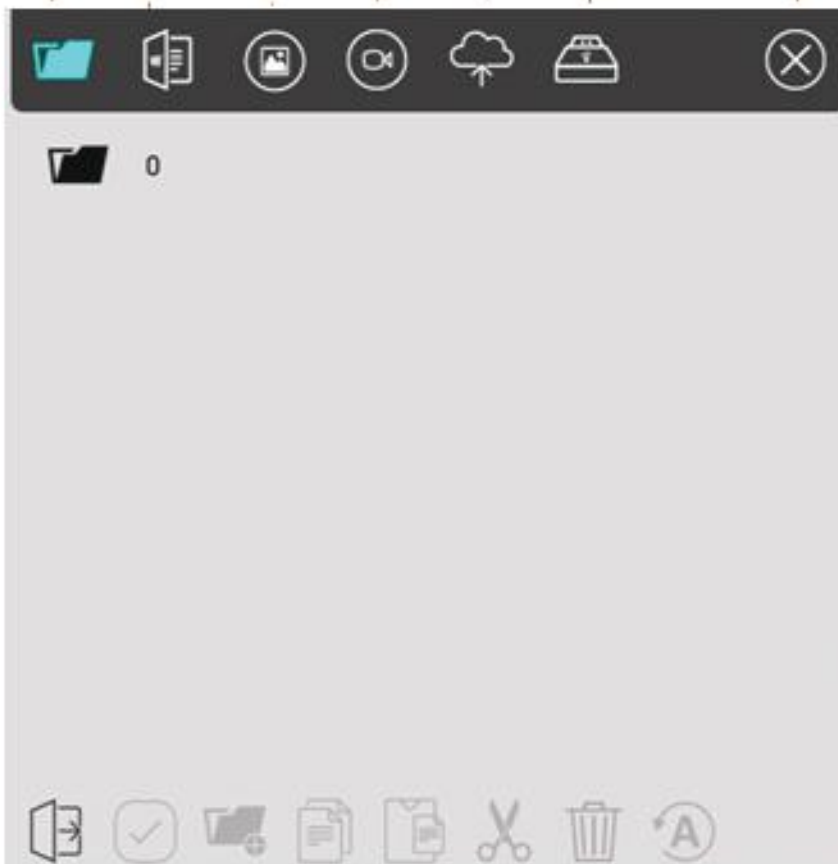

Exit

Select file

Create folder

Copy file

Paste file

Cut file

Delete file

Files rename



Following the instruction on screen to login cloud drive

Login Google Drive

Login OneDrive

## Annotation tool



Item	Description
1	Set color for thin pen
2	Set color for thick pen
3	Clean screen notes
4	Save notes as a picture
5	More setting

Set writing for thick/thin pen

Set color

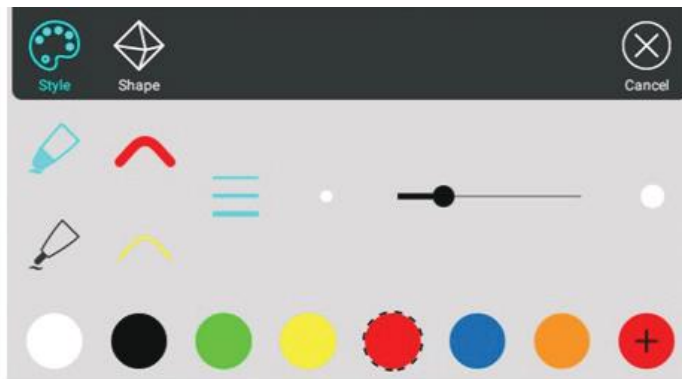

Set writing shape





## Spotlight tool

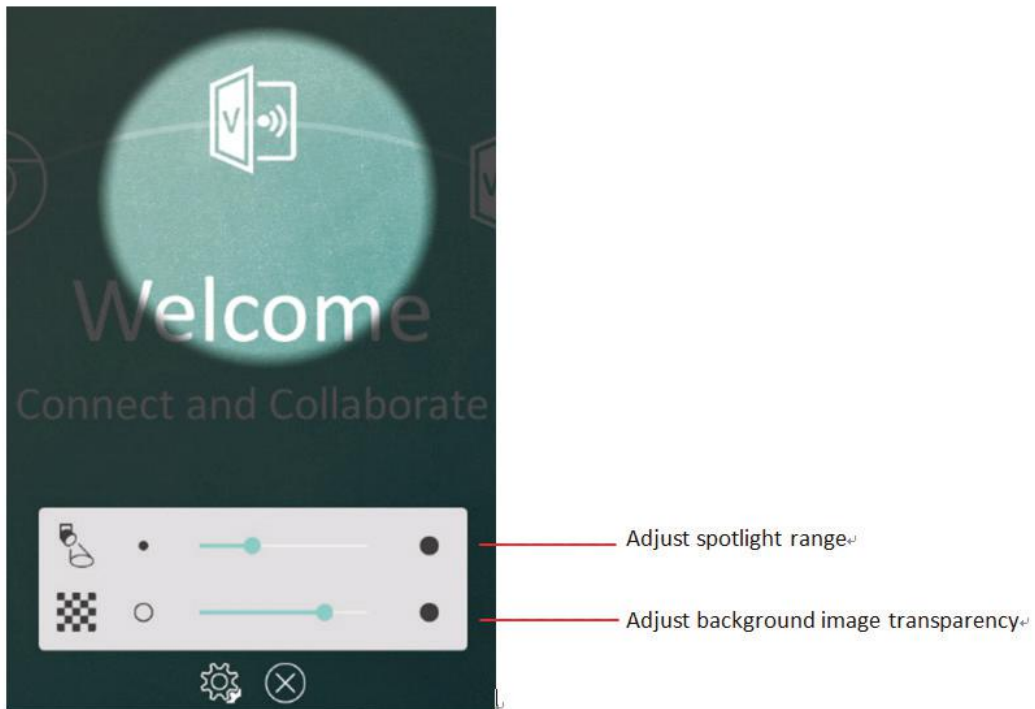

### 4.3 ViewBoard OSD (On Screen Display) Menu

ViewBoard has two methods to bring up the OSD menu:

Method 1: Click the Input button on remote control

Method 2: Gesture from edge of bottom screen





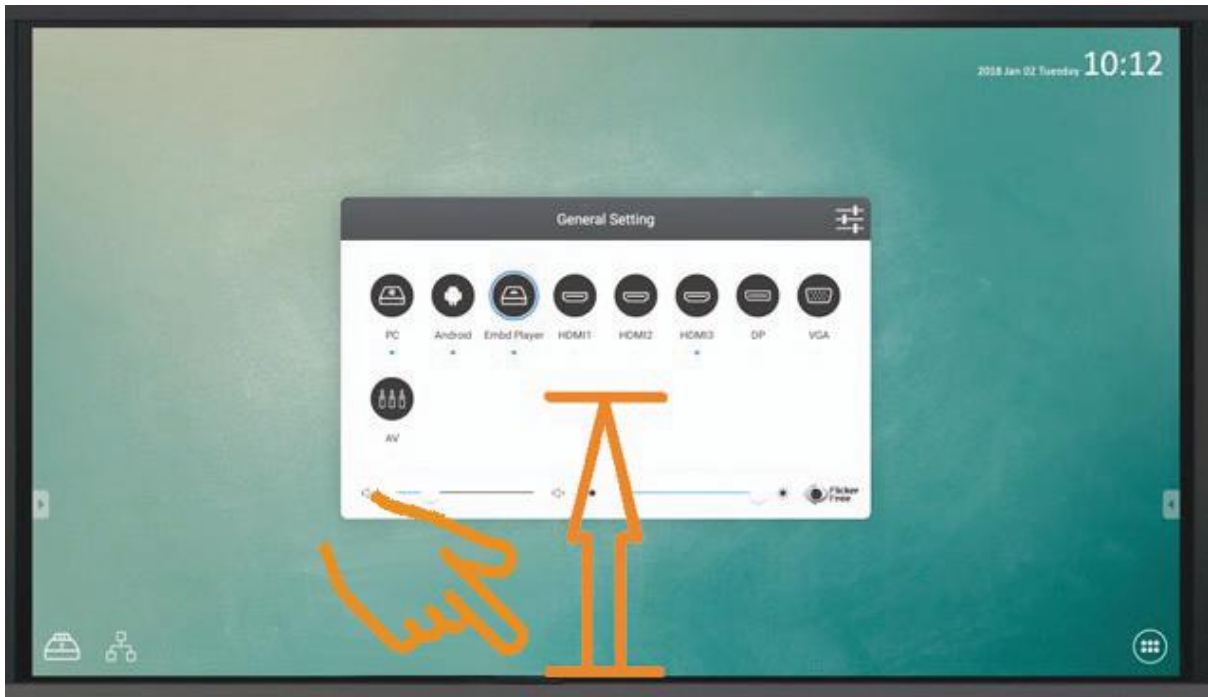

### 4.3.1 Basic setting

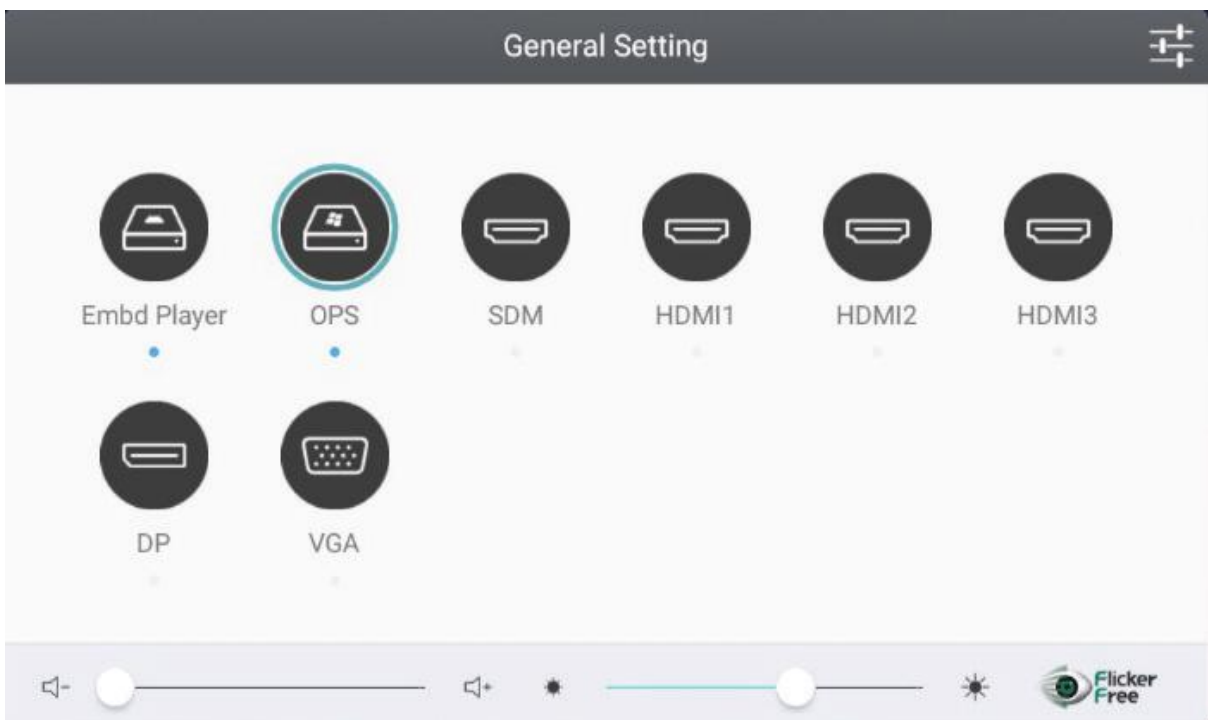

To select an input source:

1. Bring out the OSD menu by remote control INPUT key or gesture by touch panel.
2. Select an input source.  
A cyan circle on a source icon means currently channel.  
A blue dot below a source means a signal available on the channel.
3. Press BACK key by remote control or touch the screen outside OSD menu to quit close the window.



To adjust the backlight and enable/disable Flicker Free:

1. Bring out the OSD menu by remote control INPUT key or gesture by touch panel.
2. Adjust ViewBoard backlight by touch.
3. Click Flicker Free icon to enable/disable the function. When the ViewBoard backlight is 100%, Flicker free will be turned on.



To adjust the volume:

1. Bring out the OSD menu by remote control INPUT key or gesture by touch panel.
2. Adjust ViewBoard volume by touch.
3. Press MUTE icon button by remote control to enable or disable mute function.

#### 4.3.2 More OSD settings

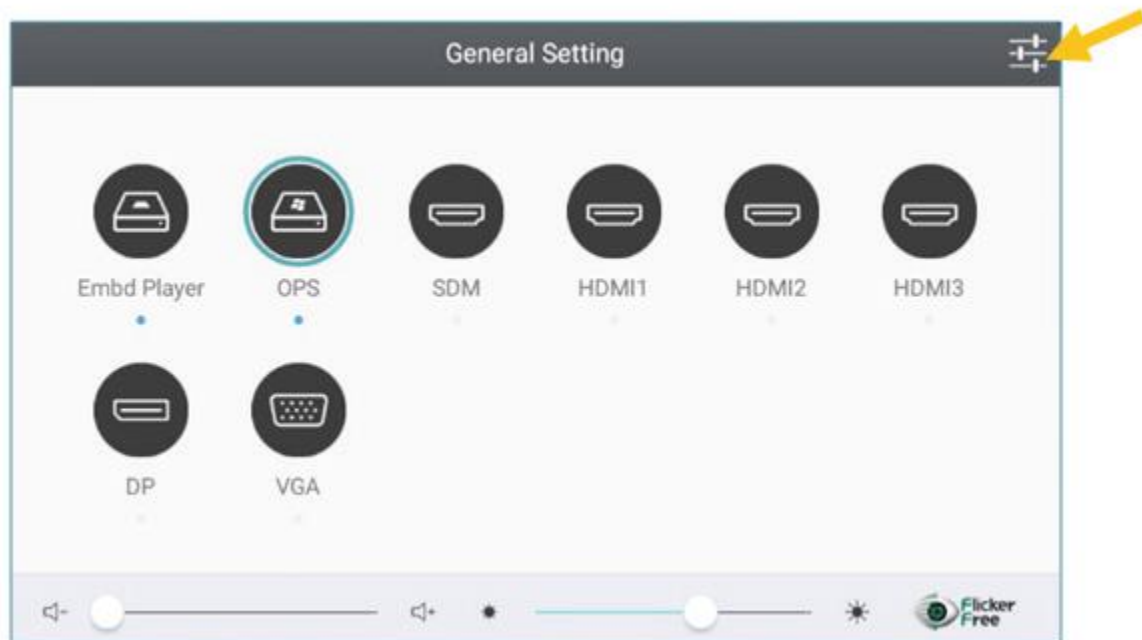

Bring out the OSD menu, press MENU button to access more settings. The setting menu only available when the input channel is not on Embd player.

## Audio Setting

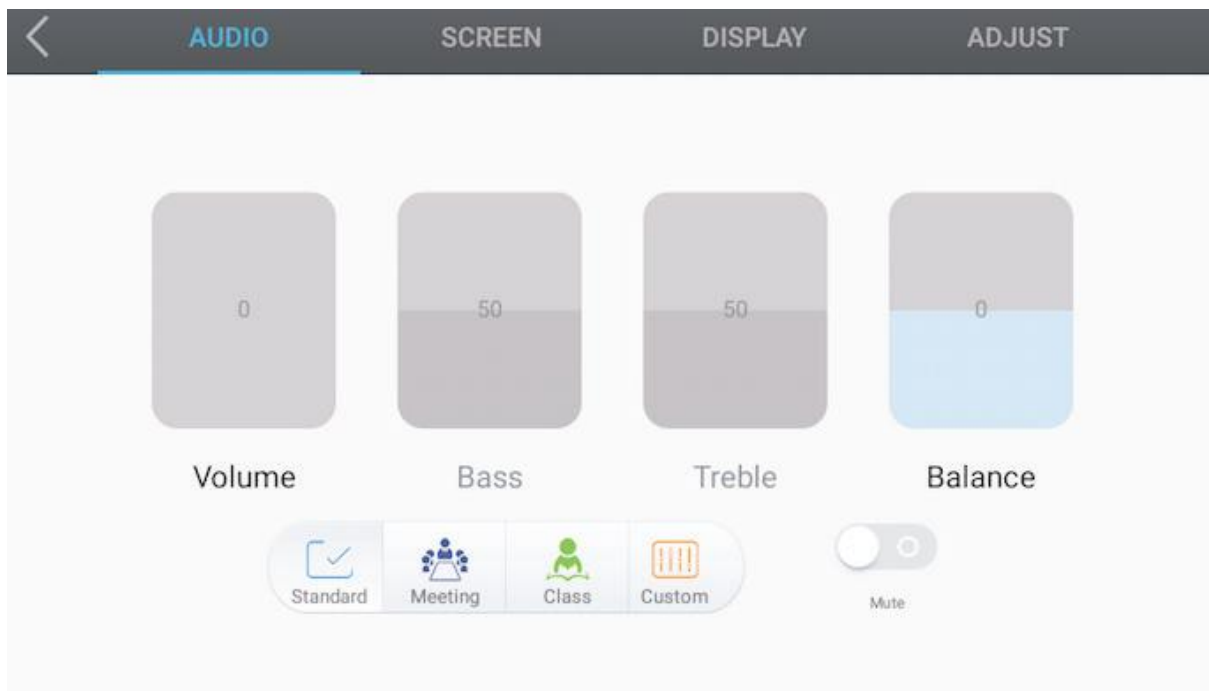

To adjust the volume:

1. Adjust the volume, bass, treble and balance by touch. Moving up or down on an item to adjust the volume.
2. Click the Standard, Standard, Meeting, Class and Custom icons to change the audio effects.
3. Click the Mute icon directly to enable/disable mute function.

## Screen Setting

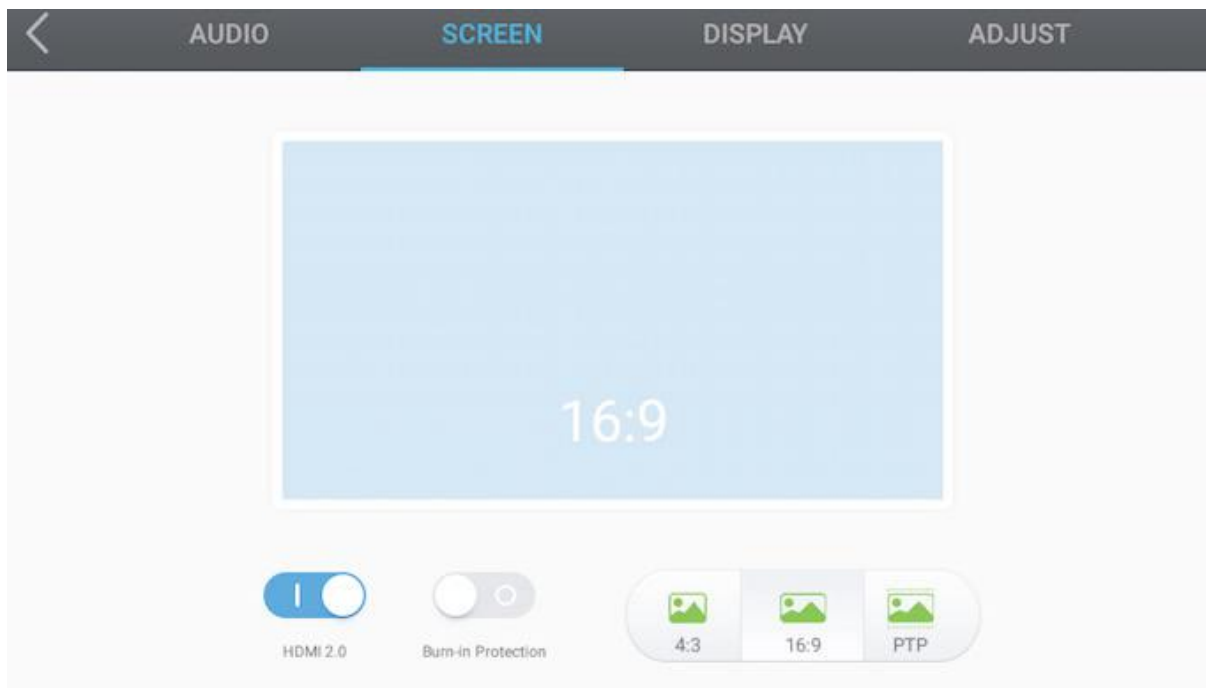

1. HDMI2.0 switch is applying for HDMI2/3. Default is on to support 3840 x 2160 60hz.
2. LCD burn-in Protection  
Turn on burn-in protection to avoid LCD burn-in issue. When the feature is on, the screen would proceed pixel shift in a specific period. You could adjust the time period from embed player > Settings> Display.  
Warning: The feature is unable to fix the LCD burn-in issue. Please note that do not keep a same image or text on screen for a long time.
3. Click the 4:3, 16:9 or PTP (1:1) icons to change the display ratio. The buttons only apply when image resolution is not on 3840x2160.

## Display Setting

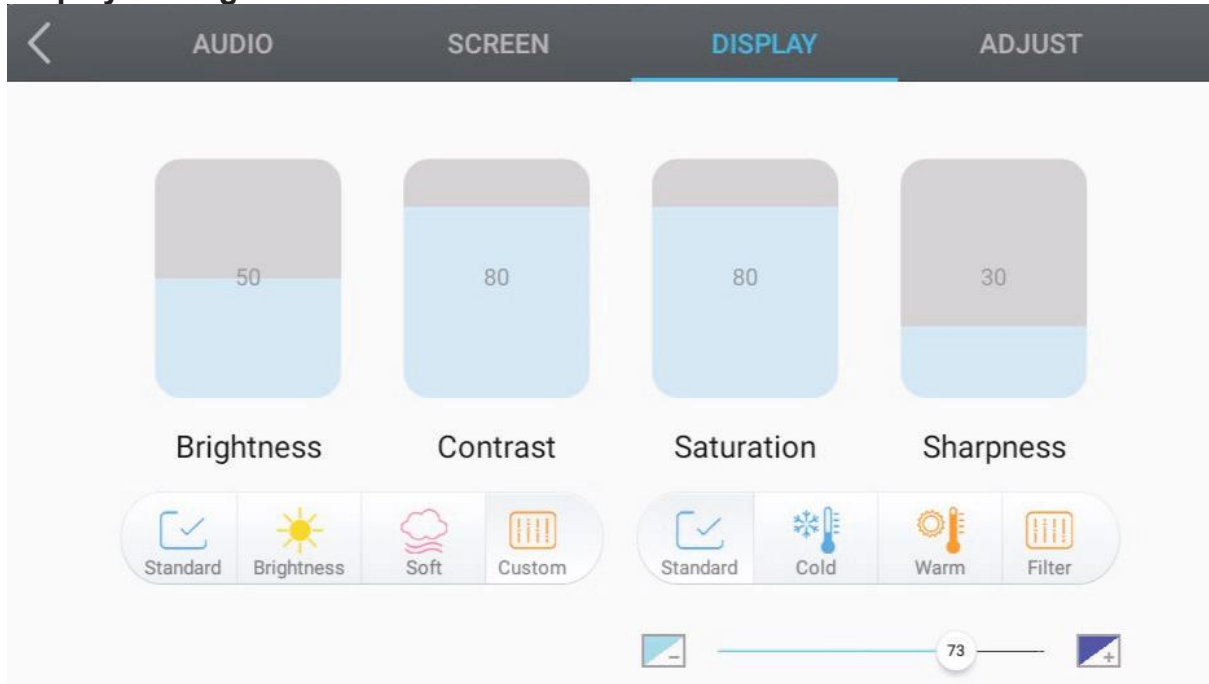

1. Adjust Brightness, Contrast, Saturation and Sharpness by touch. Moving up or down on an item to adjust the volume.
2. Click the Standard, Bright, Soft and Customer icons to change the display effects.
3. Click the Standard, Cold and Warm icons to change color temperature settings.
4. Moving  icon to adjust blue light value.

## Adjust Setting

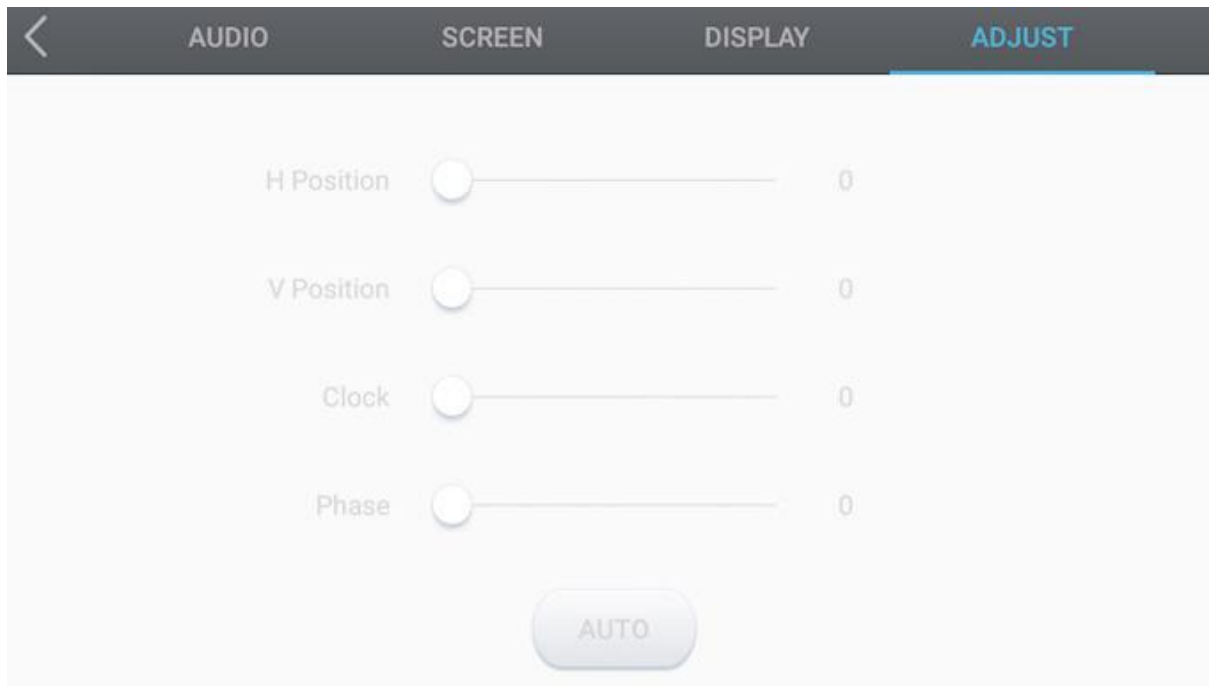

**Note:** The function only available when input a VGA signal.

1. Moving items to adjust the value.
2. Click Auto icon to proceed auto adjustment.

### 4.3.3 Embd player Advanced setting

When ViewBoard in Embd Player source, click advanced setting button in the OSD menu to enter the advanced setting menu.

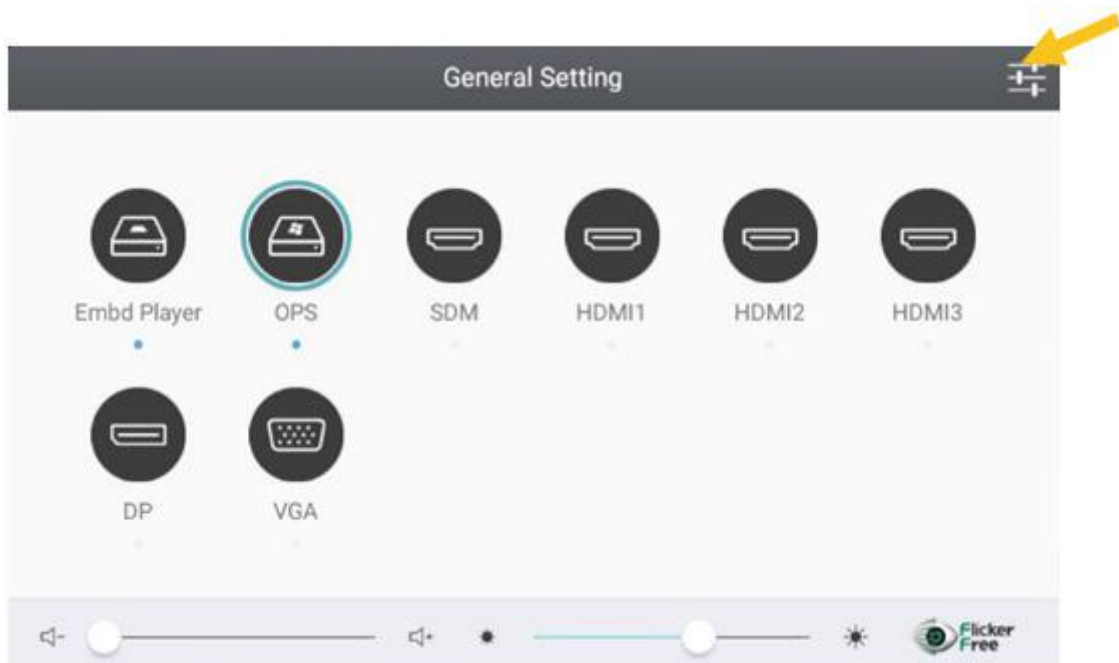

- Wireless & network: Check the current network status and adjust network settings.

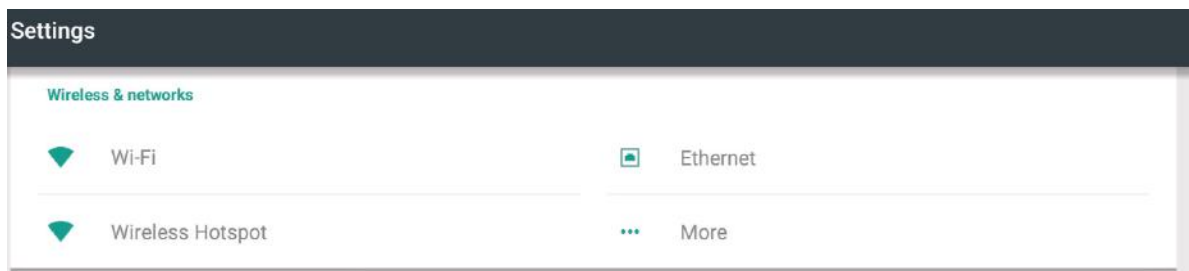

**Note:** Wi-Fi and Wi-Fi hot spot settings only appear when a supported USB Wi-Fi dongle attach on display. Wi-Fi will disable when Wireless hotspot is enable.

## Wi-fi

Click On/Off icon to on/off WiFi function.

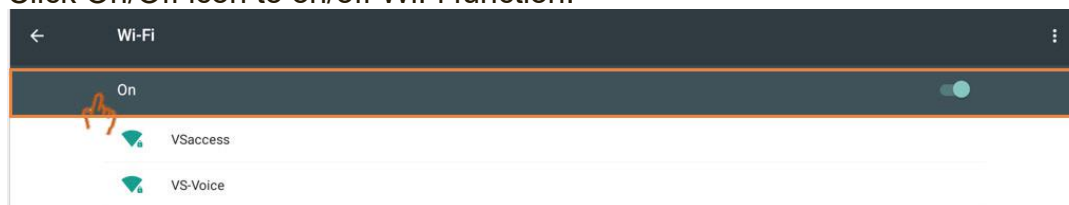

Click more settings to add network, save networks, refresh or entry advanced setting.

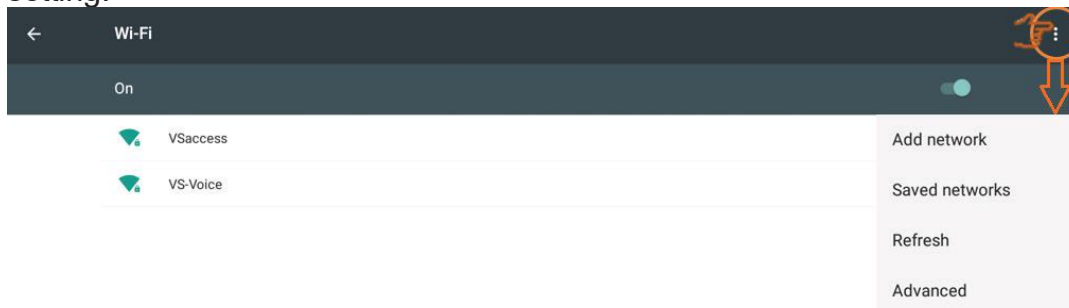

Select Add network to join a specific Wi-Fi access point which support Static IP.

### Add network

Network name

VSaccess

Security

WPA/WPA2 PSK

Password

.....

Show password

Advanced options

Proxy

None

IP settings

Static

IP address

192.168.1.128

Gateway

192.168.1.1

Network prefix length

24

CANCEL

SAVE

### Ethernet

Click On/Off icon to on/off Ethernet function.

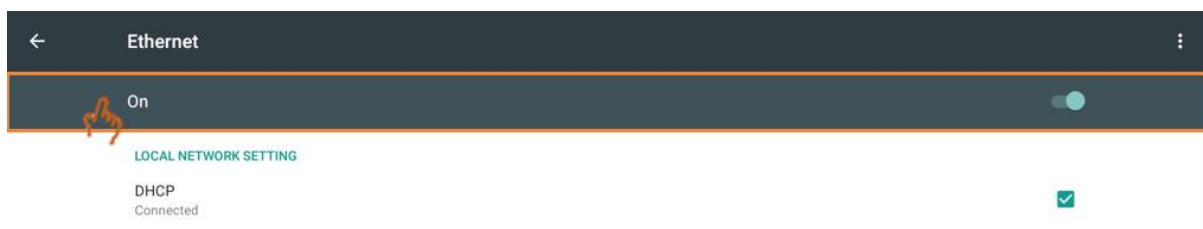

Click more settings to entry advanced setting.

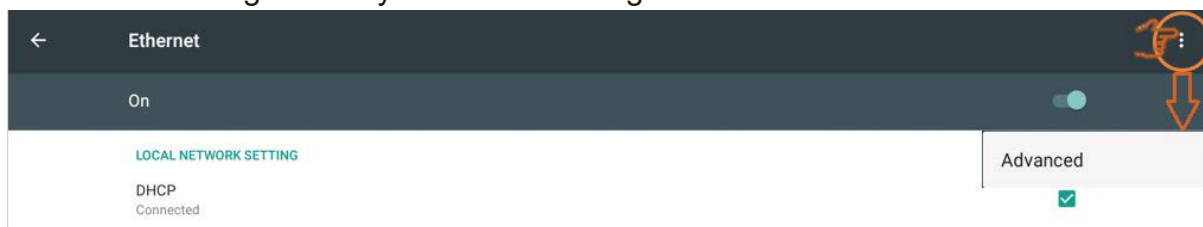



Click on static IP and input the values under a specific network environment.

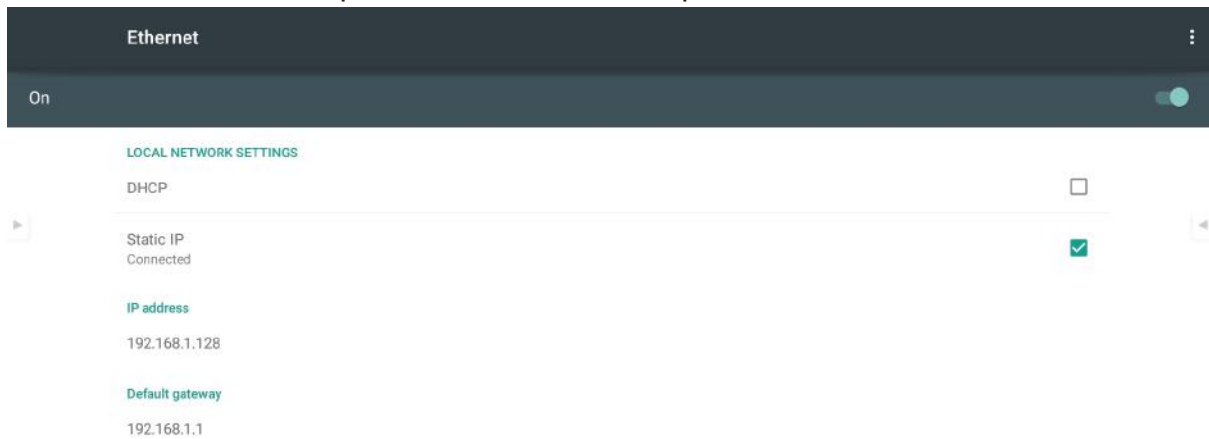

Click Proxy setting if needed.

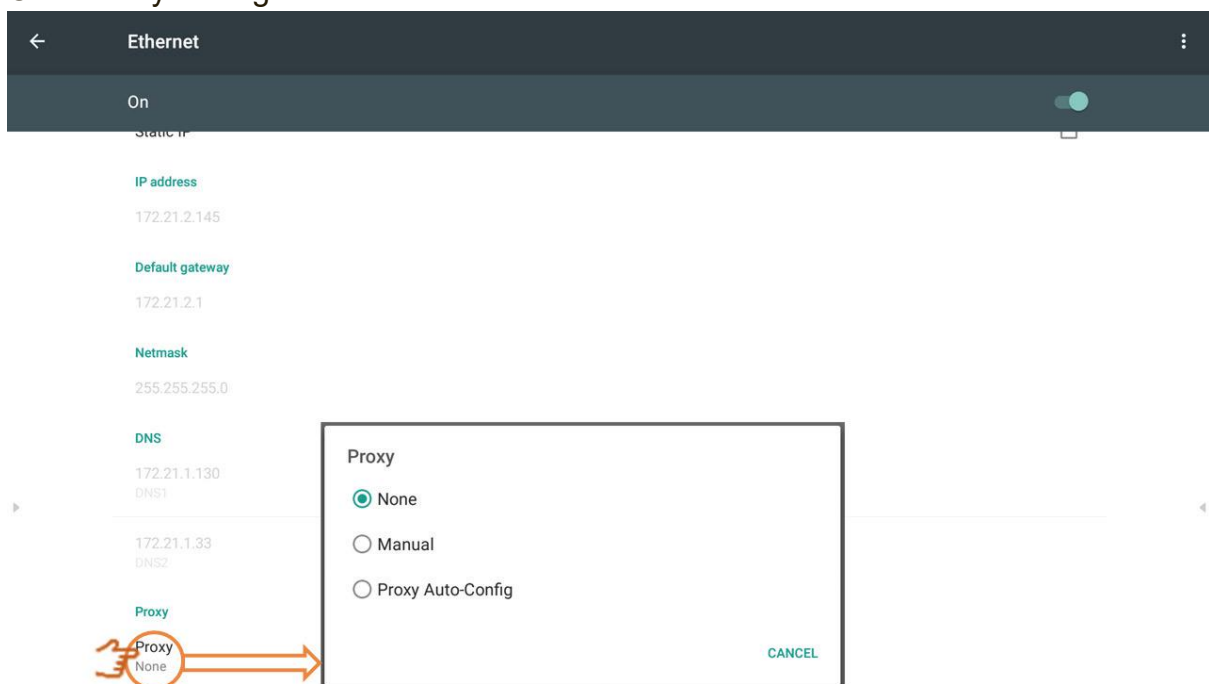

## Wireless hotspot

Click Portable Wi-Fi hotspot icon to turn on/off Wi-Fi hotspot function.



Click Set up Wi-Fi hotspot to set network name and security then save the settings value.

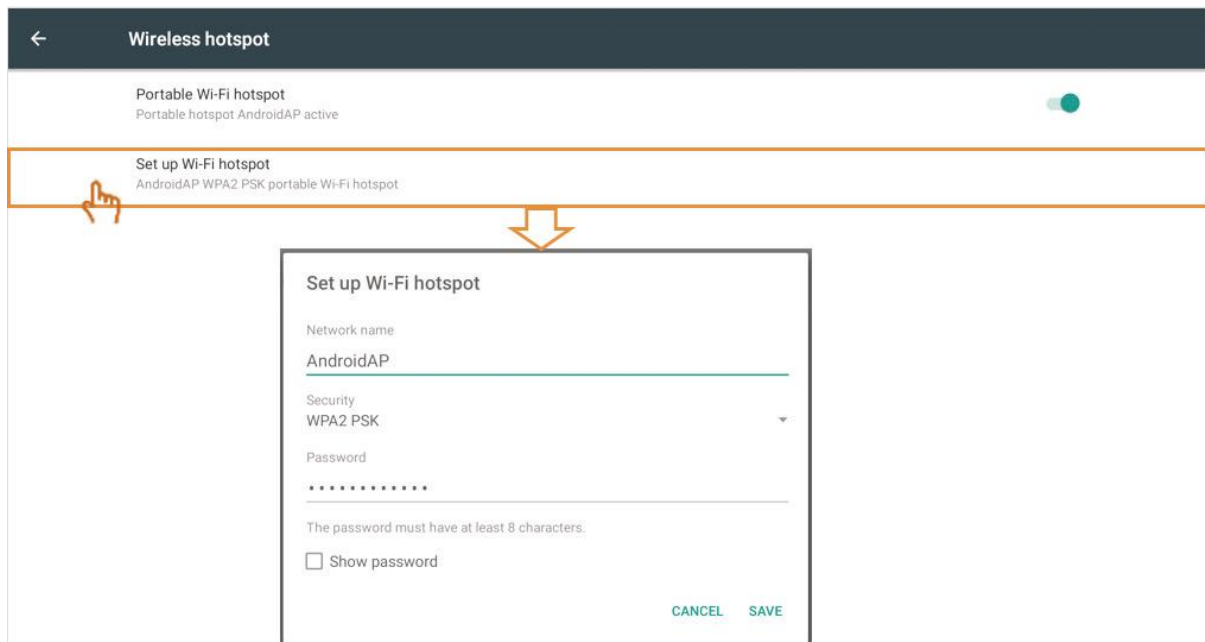

- Share: SAMBA provides files sharing services in a LAN. When enable the SAMBA service, it is allowed to access the files under embed player by a PC.

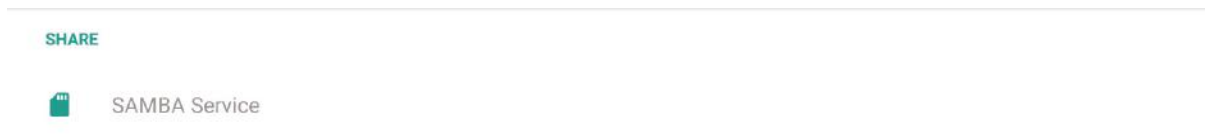

Enable SAMBA service then set password if needed. Default password is 123456.

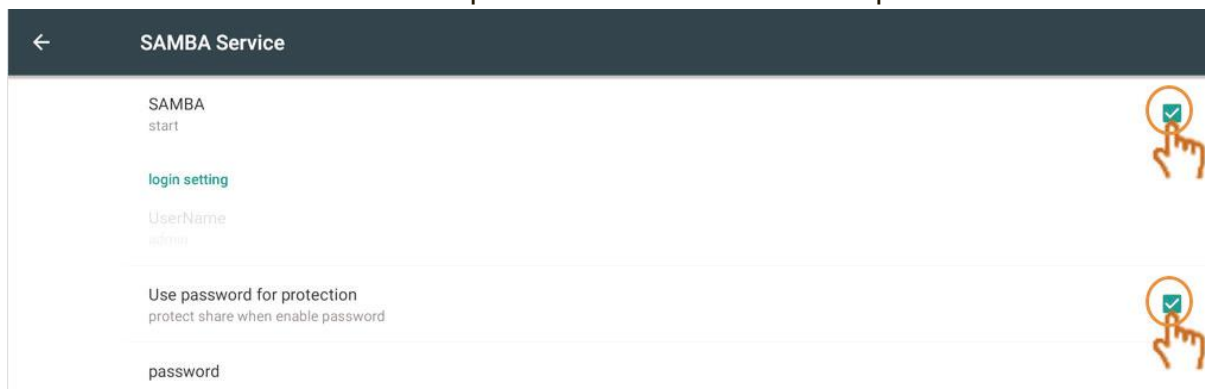

To connect ViewBoard and PC, both devices have to under a same network. Make sure they are reachable each other using the “PING” command.

### Client to ping IFP

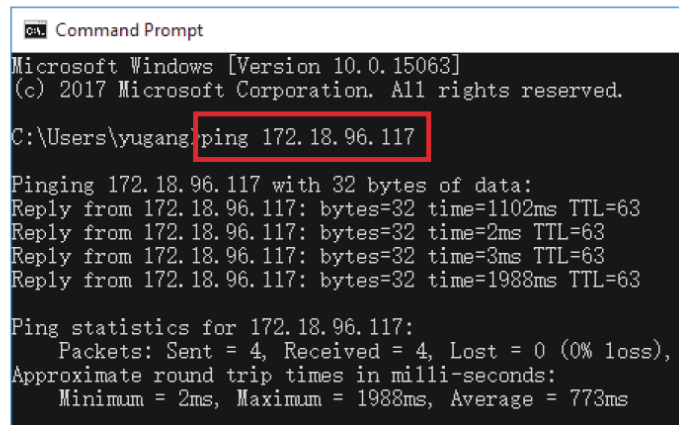
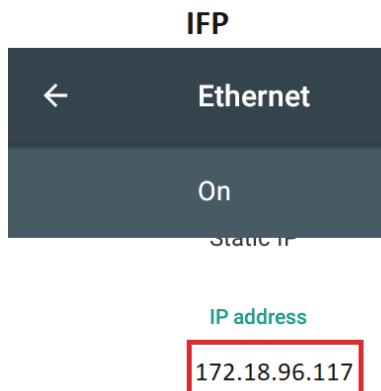

To access ViewBoard files from a Windows PC, input the ViewBoard IP address by “RUN” for file manager.

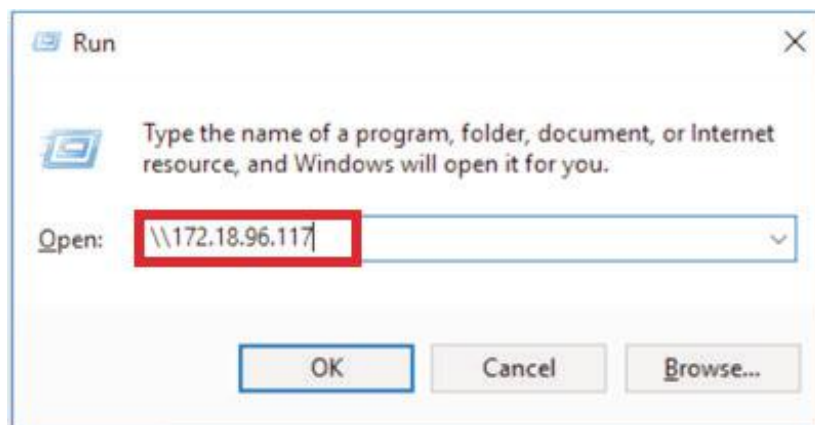

Key in the user name (admin) and password then click OK.



If successful, ViewBoard files will show on PC.

> Network > 172.18.96.117 > share

Name	Date modified	Type
asec		File folder
obb		File folder
sdcard	11/6/2017 5:15 AM	File folder
secure		File folder
shell		File folder

- Device: Adjust launcher screen, HDMI out, Burn-in Protection Interval and others.

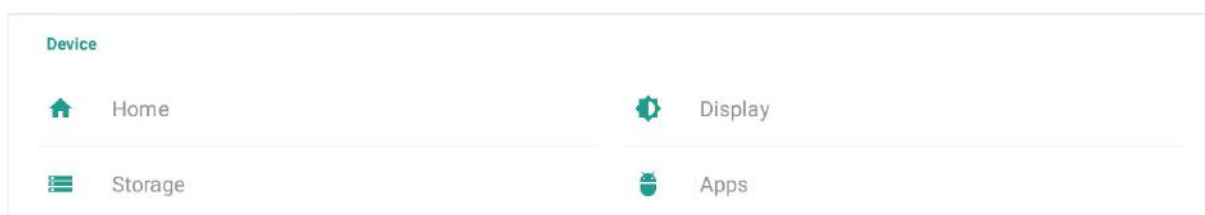

### Home:

Select different theme for embed player launcher screen

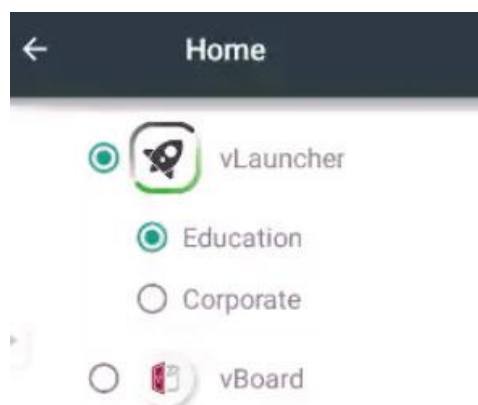

vLauncher: a Home screen with application shortcuts to access specific function easily.

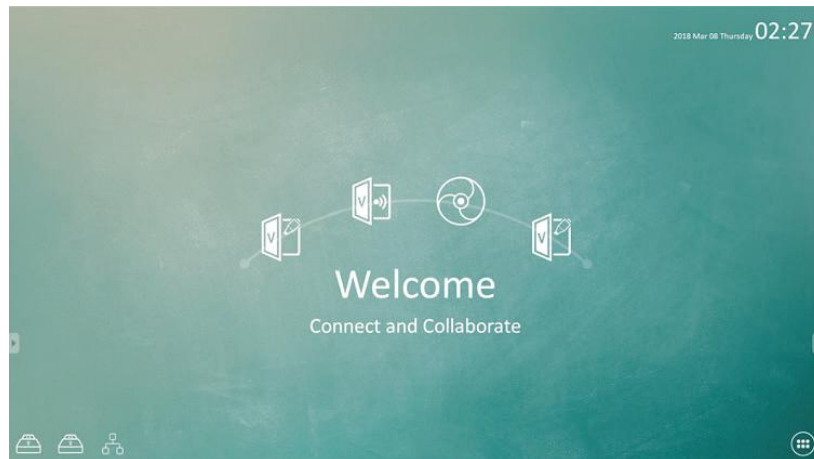

vBoard: Set the digital white board as home screen. It's easy and quickly to do a memo when you come out an idea.

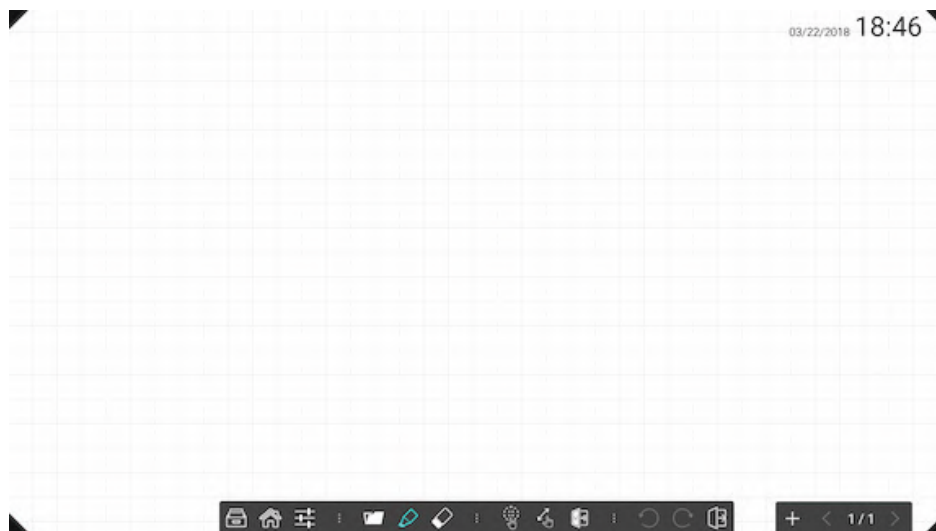

Display:

To set wallpaper, HDMI out encryption, burn-in protection interval, Intelligent Eye Protection and HDMI out resolution

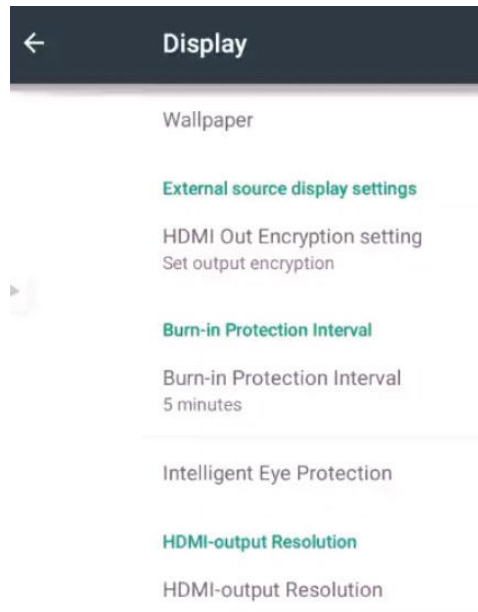

Wallpaper: Pick an image to change the wallpaper.

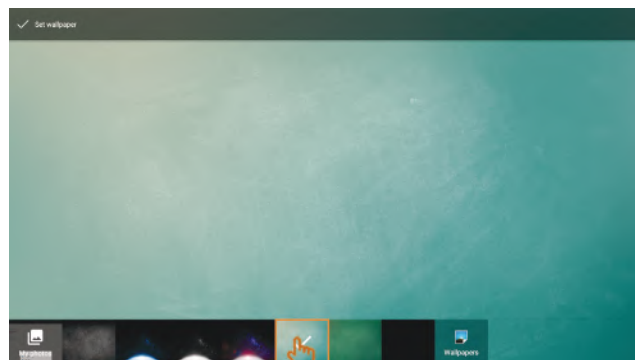

HDMI out Encryption setting: Select On/Off to set signal with HDCP or not. Default is set to ON to compatible with most display.

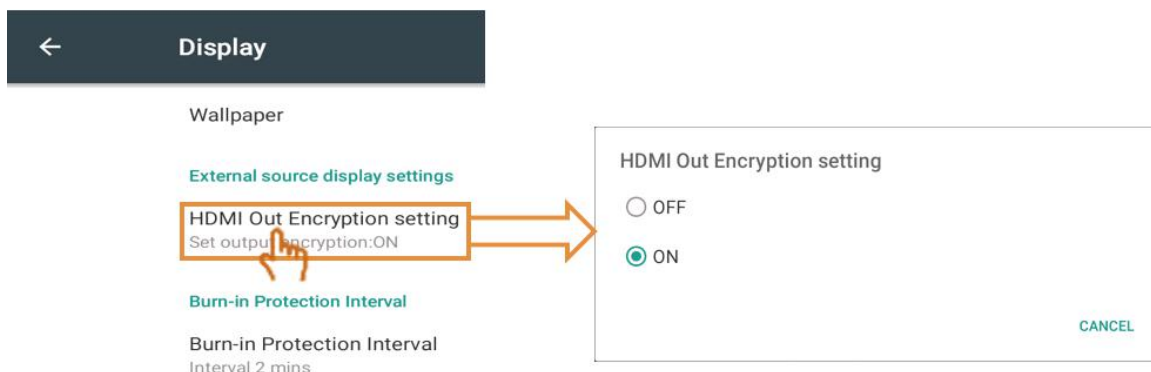

Burn-in Protection Interval: The Burn-in Protection Interval is allows you to set the Interval time period.

**Note:** The burn-in protection function should be enabled from OSD menu. The feature is not apply for embed player.

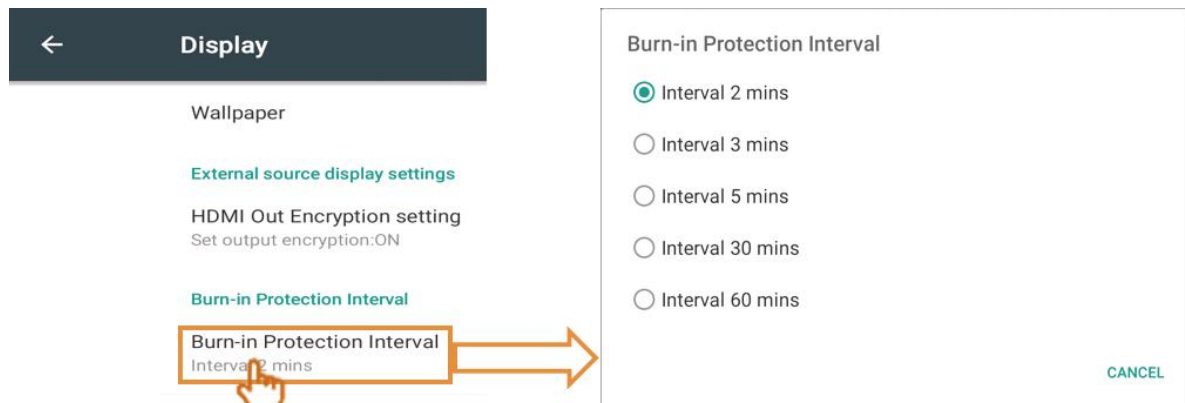

Intelligent Eye Protection: When enable the function, ambient light sensor will be activated. ViewBoard would adjust panel backlight automatically.



Storage:  
Click to check the storage status.

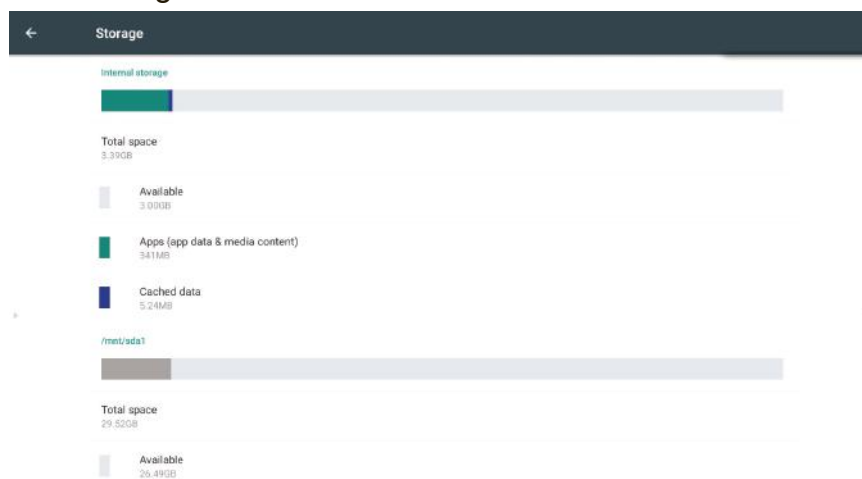

## Apps:

To see the apps information, force stop and uninstall applications.

**Note:** Build in apps can't be uninstalled.

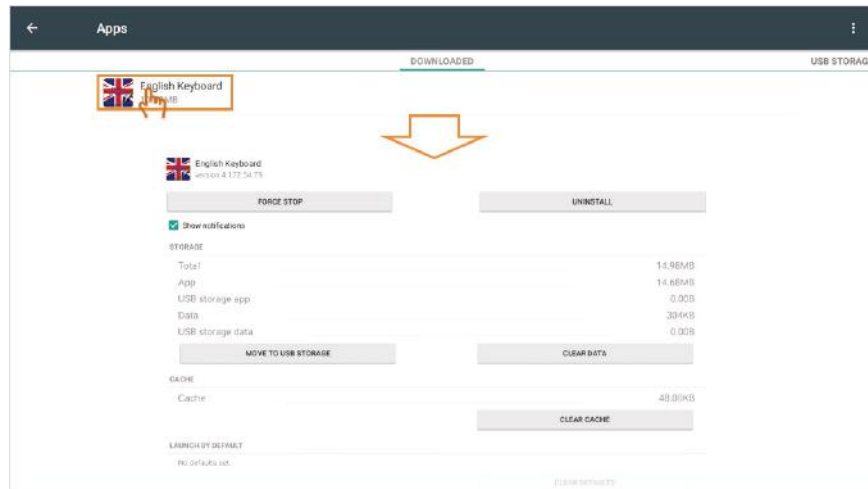

Click right upper icon to sort apps by size, by name and reset app preferences.

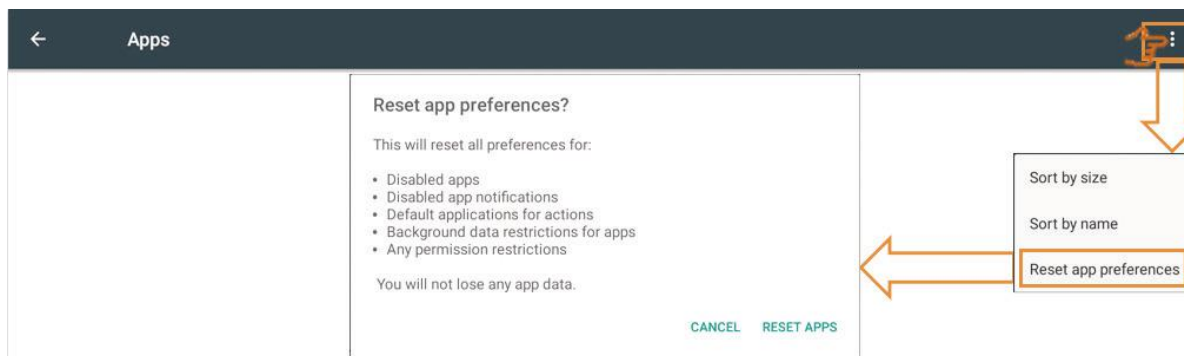



• **Personal**

The settings are for security, language & input, startup and shutdown, password, input setting and others.

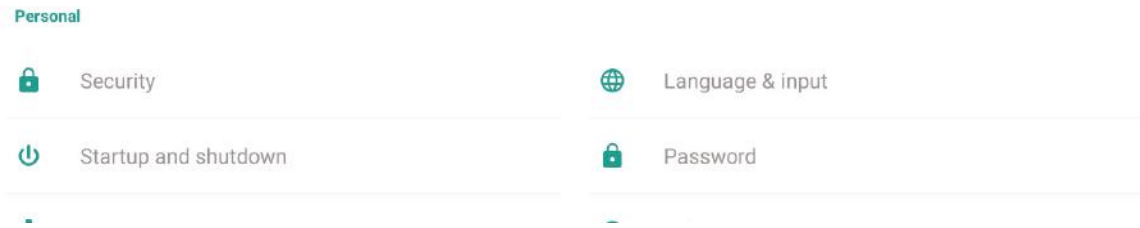

**Security:**

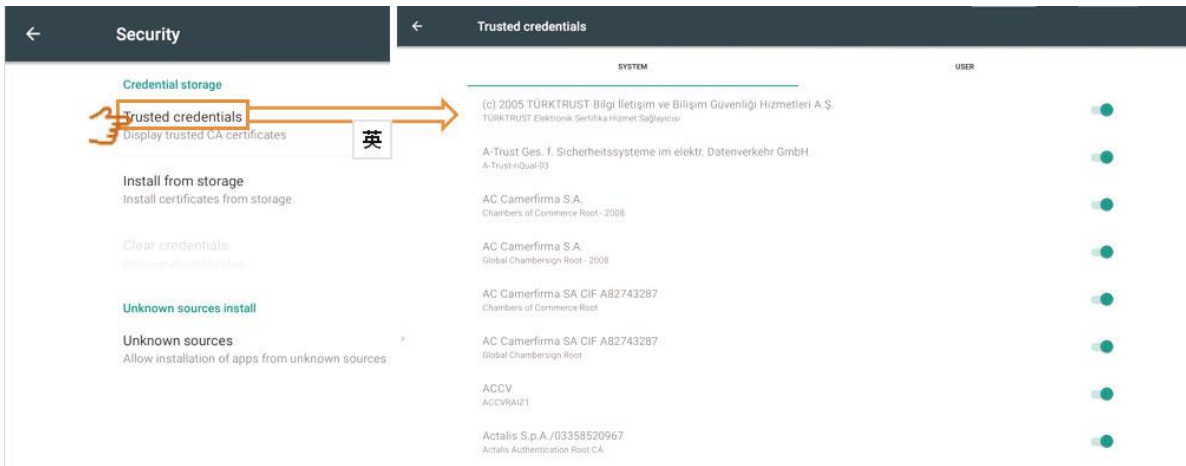

Trusted credentials: Click to show all CA credentials has install on ViewBoard.  
Install from storage: Click to install needed credentials from internal storage or USB drive.

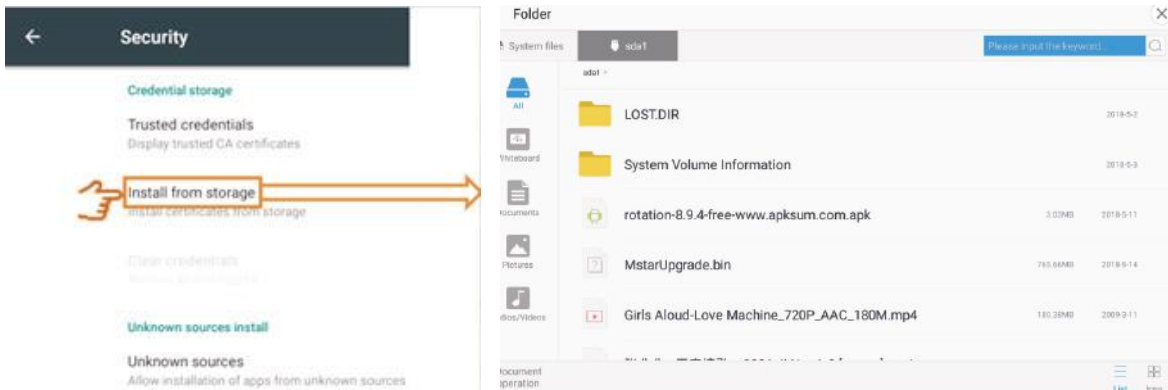

Clear credentials: Click to clear installed credentials.

**Note:** The preloaded credentials can't be clear.



Unknown sources: Click to allow unknown source function.

**Note:** Needs to enable unknown source function before install apps. There is no guarantee all APK compatible with ViewBoard.

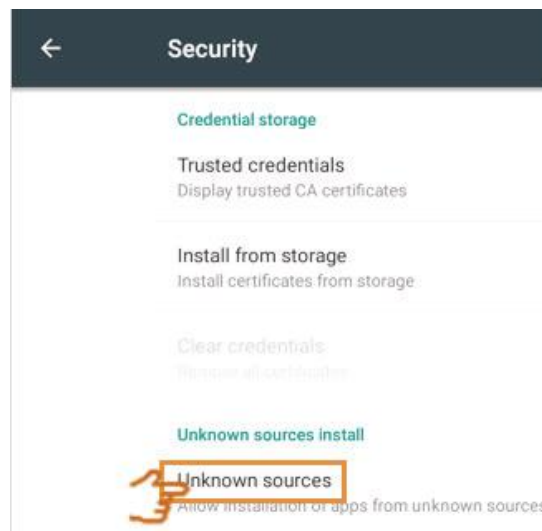

Language & inputs: Adjust language and input method of Embedded Player.

Language: Click to select language.

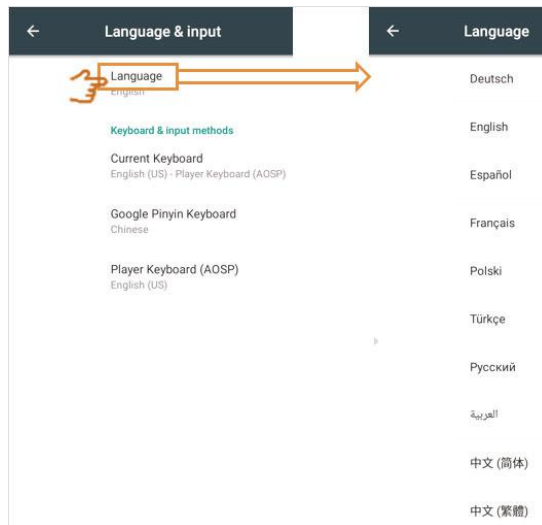

Current Keyboard: Click to enable/disable visual keyboard or change default input method.

Existing keyboard: Click to entry advanced settings.

Startup and shutdown: Set the Startup channel, Standby Mode, Black screen after startup and On/Off timer.

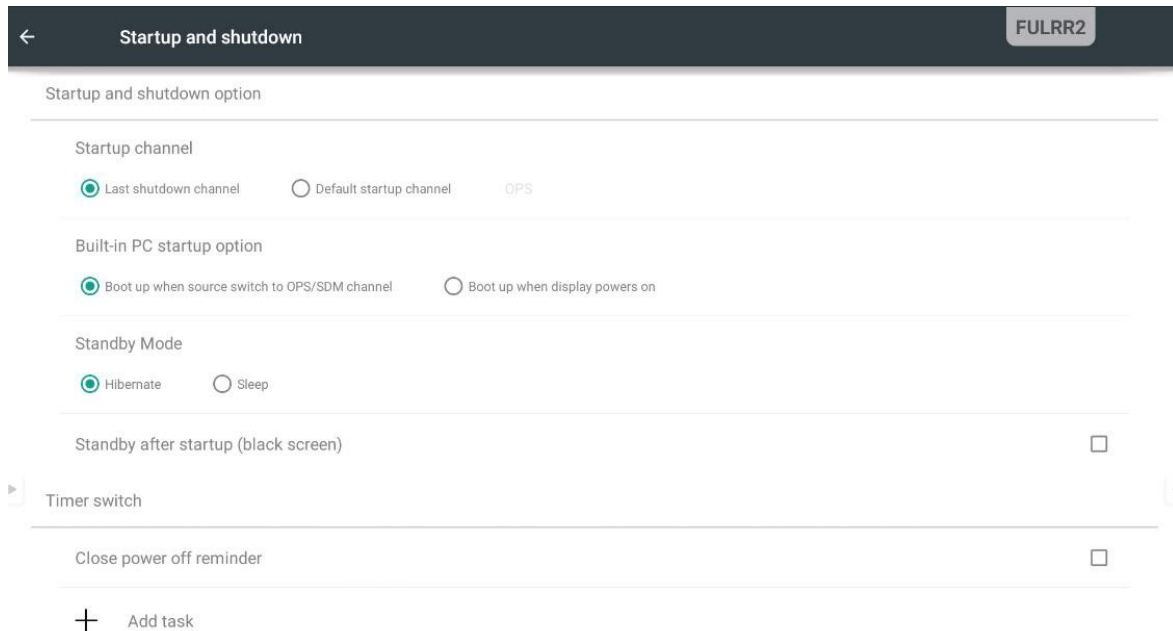

Startup channel: Set boot up channel from the last shutdown channel or a specific source.

Built-in PC startup option: It set PC module boot up options. Default is set on boot up PC module when switch the channel to OPS or SDM (IFP7560 only).

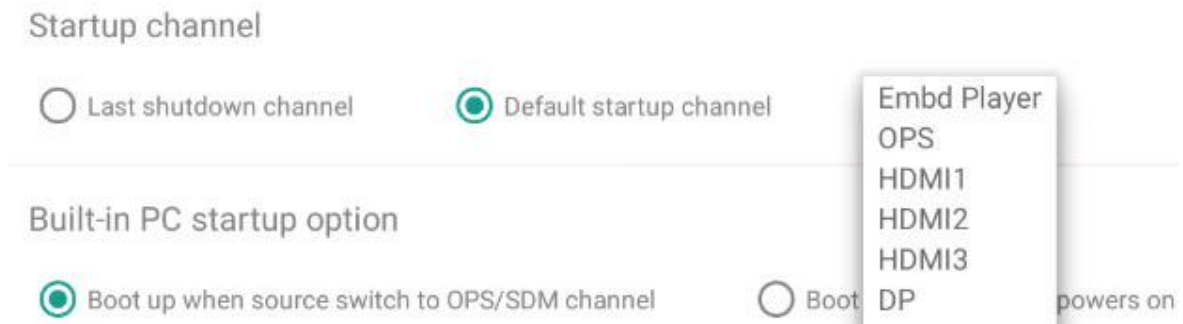

Power Standby mode:

Hibernate: ViewBoard would turn off panel and whole system when set on hibernate mode. It is allowed to wake up ViewBoard by Power button, remote control and RS-232 command. Waking up by LAN is not support on Hibernate mode.

Sleep Mode: ViewBoard would turn off major function and panel. The operation system is still running when set on Sleep mode. It is allowed to wake up ViewBoard by Power button, remote control and RS-232 command. Wake up by LAN is supported on Sleep mode.

Black screen after startup: ViewBoard will turn off backlight automatically after boot on from standby mode. User is able to wake up display easily by press power button.

Close power off reminder: ViewBaord will turn off directory without countdown timer if enable the feature.

On/off timer: Click + to add a schedule.

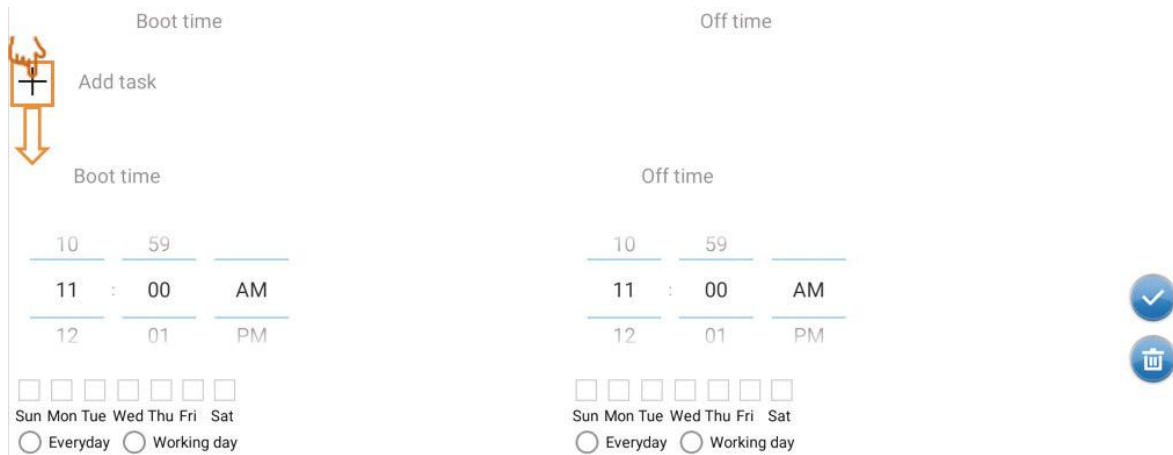

Swipe to adjust the value and select day then click  to save the setting.

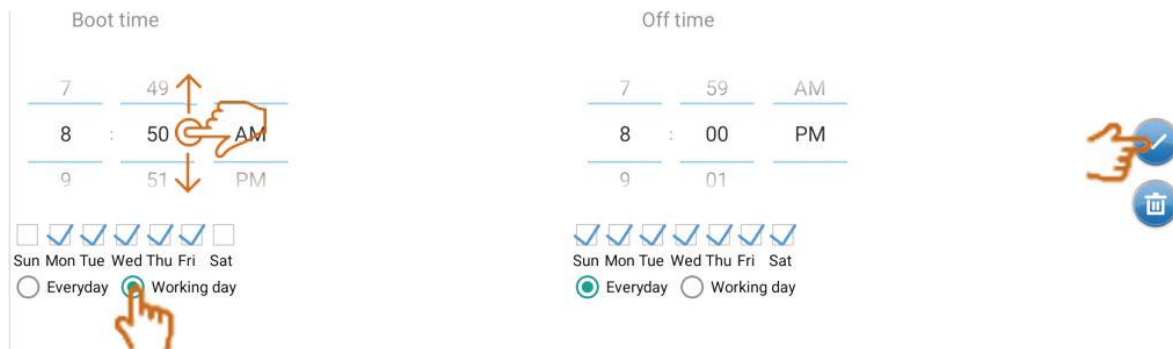

Password: Set the screen lock password.

Please contact local service center if you forget the password.

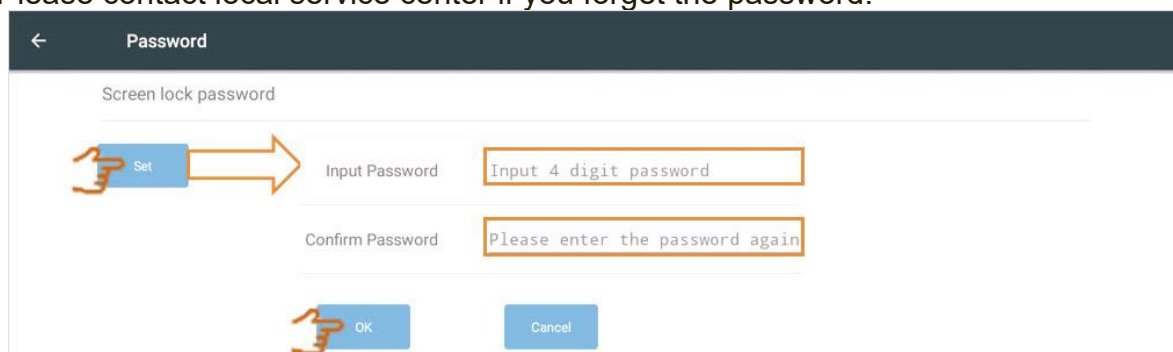

## Input setting:

### Input Setting

Input Alias Switch

Embd Player	Embd Player
HDMI1	HDMI1
HDMI2	HDMI2
HDMI3	HDMI3
OPS	OPS
DP	DP
VGA	VGA

Wake Up by Active Source

Signal Auto Search

Signal Auto Switch When plug-in a New Source

No Signal Auto Off

09

Set no signal auto-off to 10 minutes.

11

HDMI CEC

Player off then display off

Display off then player off

Player on then display on

Display on then player on

## Input alias switch:

Allow user to define specific name for each channel.

## Wake up by active source:

When the function enable, ViewBoard would keep watching input signal in standby mode. If there has a signal input ViewBoard, it would power up automatically.

**Note:** The feature may not compatible with each device due to different power saving designed. Some device may keep sending 5V signal even is under sleep mode. ViewBoard is unable to trigger wake up by active source on this condition.

### Signal Auto search:

When the function enable, once currently source lost signal, display will search available source automatically. If there is no available signal, display will stay on currently channel and show “No Signal”.

**Note:** The feature may not abnormal when get a device keep 5V signal alive even it is in power off mode. ViewBoard may always detect the device and switch to the channel..

### Signal Auto switch when plug-in a new source:

ViewBoard would switch to new channel when plug-in a new source.

### No signal power off:

ViewBoard will go off when no signal for a specific time. Default is set on 10 mins.

### HDMI CEC:

All HDMI support CEC function. When the function enable, ViewBoard is able to control on/off by a HDMI CEC device.

**Note: 1.** “Player off then display off”, “Display on then player on” are not standard CEC command. ViewBoard may not compatible with all player. **2.** “Sleep mode” not support HDMI CEC function.

## • Other settings

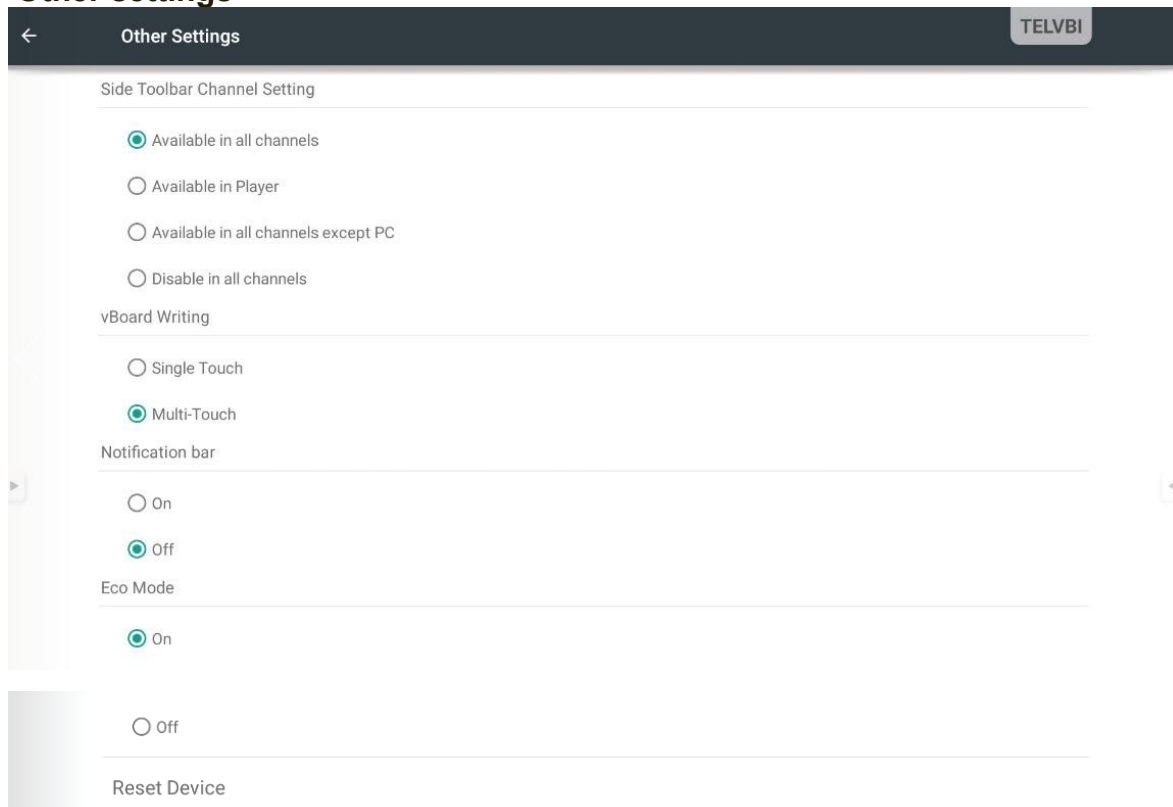

Side toolbar channel setting:

To set side toolbar available channel.

vBoard writing:

To change the vBoard touch mode by single or multiple touch.

Notification bar:

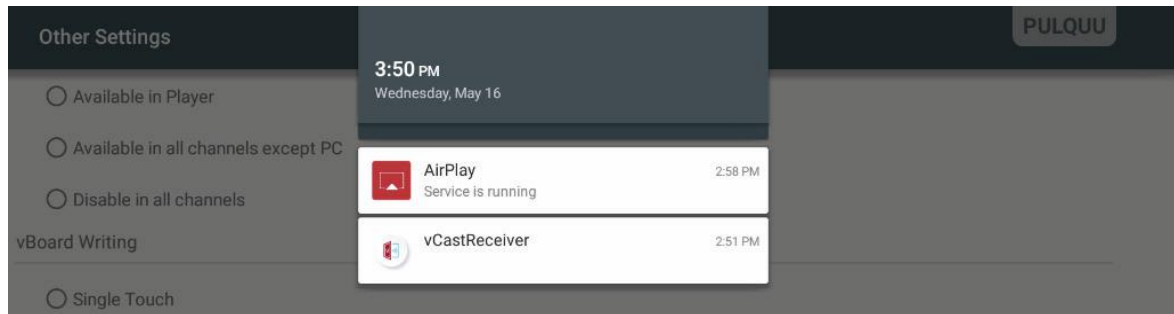

When turn the function on, it is able to draw down the process menu from the top of screen. The menu is only available in Embed channel.

ECO mode:

Display backlight will turn off when idle for 5 mins automatically. Turn off the option if you need to use display continuously.

**Note:** When display image by HDMI, DP or VGA, suggest disabling ECO mode to avoid ViewBoard backlight auto turn off.

Reset Device:

It will reset whole system as first turn on display. It will run Startup Wizard after reset device.

**Note:** Personal data and information will be removed from display. There is no impact for the date saving in PC module.

Date & time:



Automatic date & time: When the function enable, IFP will synchronize date and time with Internet.

**Note:** The Ethernet or Wi-Fi connection needed.



Set date:  
Swipe to adjust the value then click OK to save.



Set time:  
Swipe to adjust the value then click OK to save.

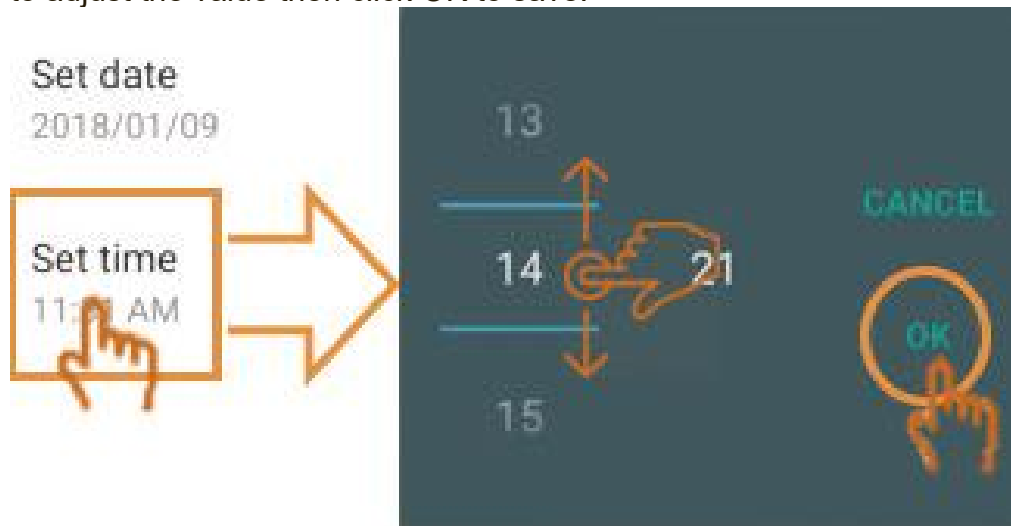

Select time zone:  
Click to select different time zone.

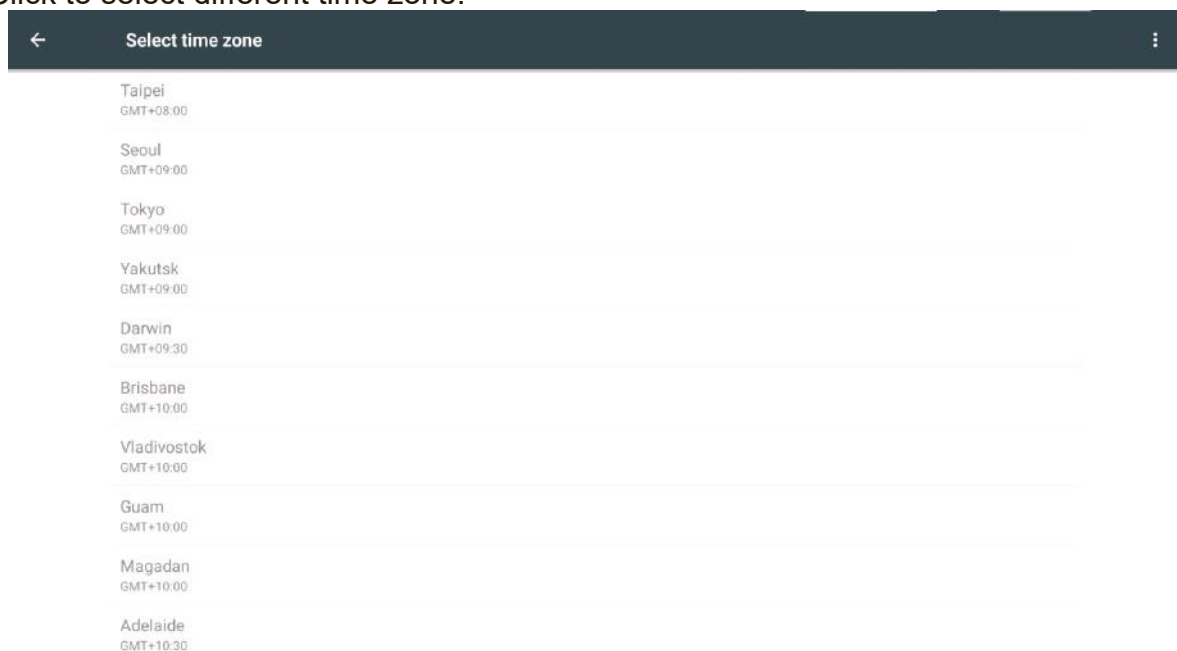

Select time format:

Click to select different time format.



Choose date format:

Click to choose different date format.



About Device:

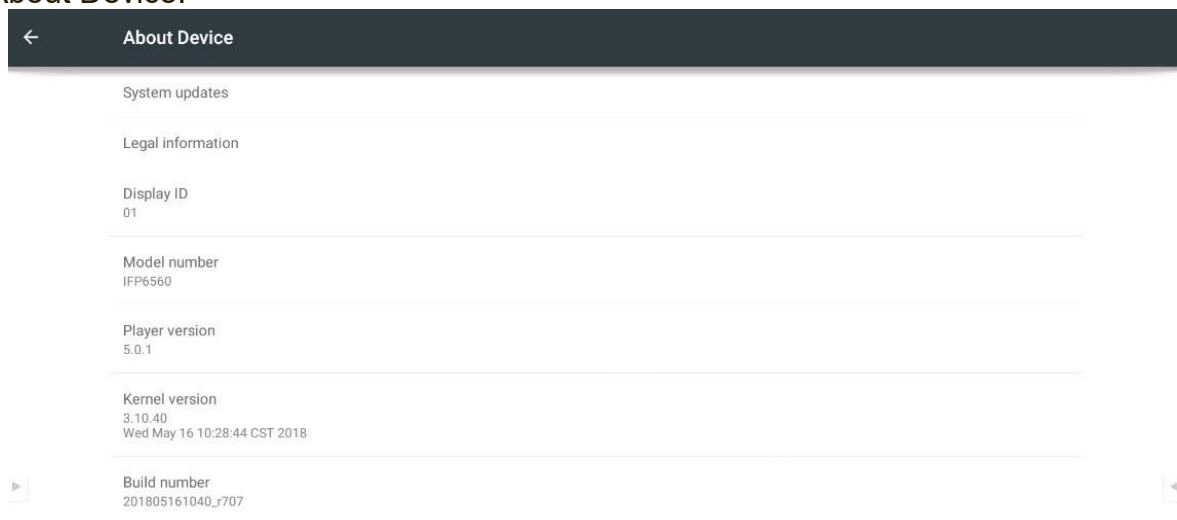

## System Updates:

Update by OTA, it requires network connection. Press the check button, display will check any new upgrade package from ViewSonic server. If has new version, user will see following processes and proceed system update.

**Note:** When proceed update by OTA, user data won't be removed from device.

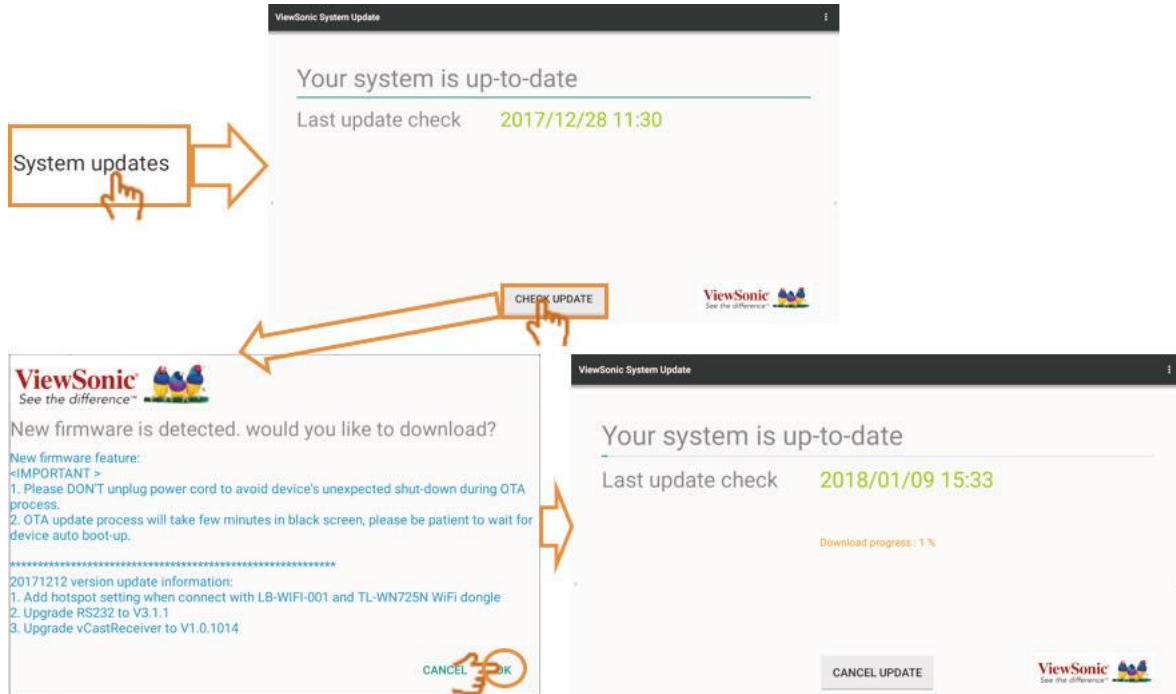

## Update by USB:

When an update BIN file available from ViewSonic website, user is able to download and update system by USB dongle.

### Process

1. Download upgrade package and unzip the file. You could get a file named MstarUpgrade\_828.bin.
2. Copy the file to a FAT32 USB dongle on the root folder. Plug-in the USB dongle to the rear USB port of display then proceed system update by USB.
3. You will see the below information on screen. Please do not turn off power before the processes finish. Display will reboot automatically when it done.

**Note:** User data will be removed when update system by USB. The data in OPS/SDM won't be removed.

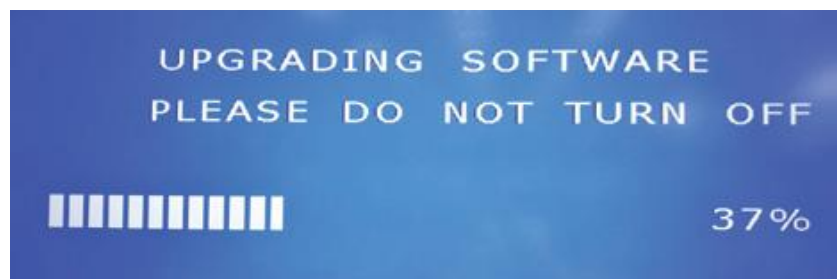

Legal information: Click to check the open source licenses

Legal information → Open source licenses

**Open source licenses**

- [/kernel](#)
- [/system/lib/libbluetooth.a](#)
- [/system/lib/libgccdemangle.a](#)
- [/system/lib/libgccdemangle.so](#)
- [/system/bin/dnsmasq](#)
- [/system/bin/ip6tables](#)
- [/system/bin/iptables](#)
- [/system/lib/libext.a](#)
- [/system/lib/libext4.a](#)
- [/system/lib/libext6.a](#)
- [/system/lib/libip4tc.a](#)
- [/system/lib/libip6tc.a](#)
- [/system/lib/libxtables.a](#)
- [/root/file\\_contexts](#)
- [/root/init](#)
- [/root/property\\_contexts](#)
- [/root/sbin/adbd](#)
- [/root/sbin/mkfs.f2fs](#)
- [/root/seapp\\_contexts](#)
- [/root/selinux\\_version](#)
- [/root/sepolicy](#)
- [/root/service\\_contexts](#)
- [/system/app/CertInstaller/CertInstaller.apk](#)
- [/system/app/HTMLViewer/HTMLViewer.apk](#)
- [/system/app/PackageInstaller/PackageInstaller.apk](#)
- [/system/app/Provision/Provision.apk](#)

Display ID:

The function was designed for RS-232 and LAN control. Display default ID is set on 01. Available ID period is between 01 and 98. 99 is for command broadcast which send from control side.

Display ID

1

CANCEL OK

# 5. ViewBoard Embedded Application and Setting

**Note:** Applications function may update by OTA. The interface and function may modify without notice.

## 5.1 vBoard

vBoard user interface:



Click  to open up the setting window.



### (1) Brightness adjustment



### (2) Background color adjustment



### (3) Volume adjustment



(4) More setting option: Quick link to the embedded player setting, vBoard supports 10-point writing by default user could go the setting mode and switch back to single point writing.

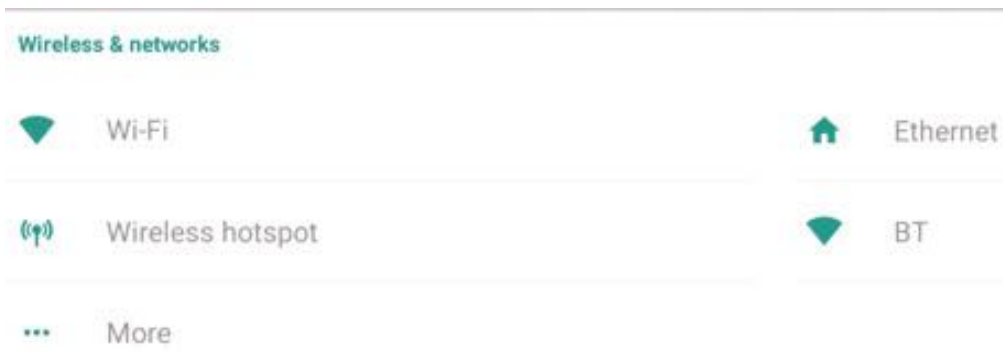

### (5) Information “about” this vBoard.

- Pen: click  to open more pen option.

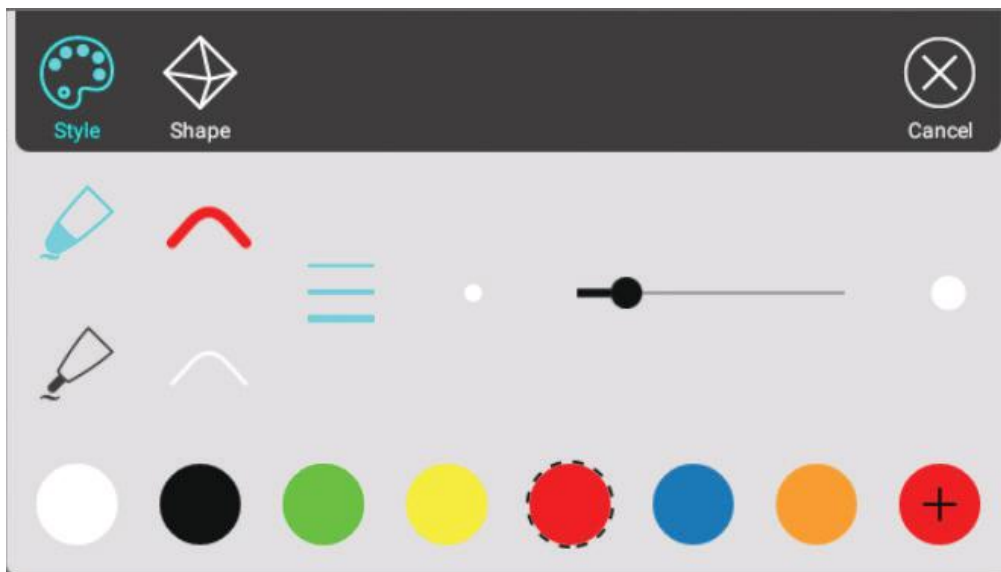

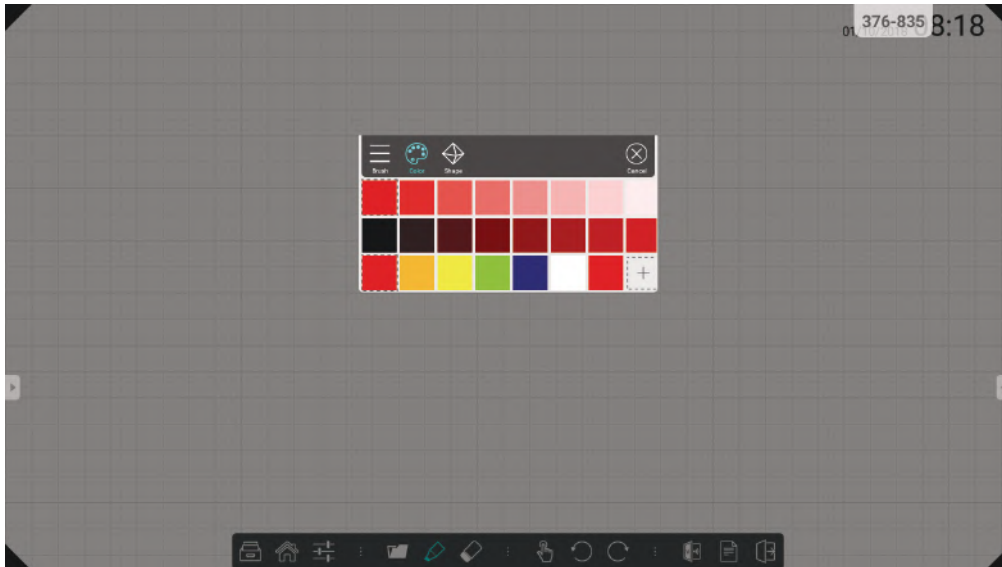

Select pen thickness and type



Change pen color







Tool to draw line and different shapes

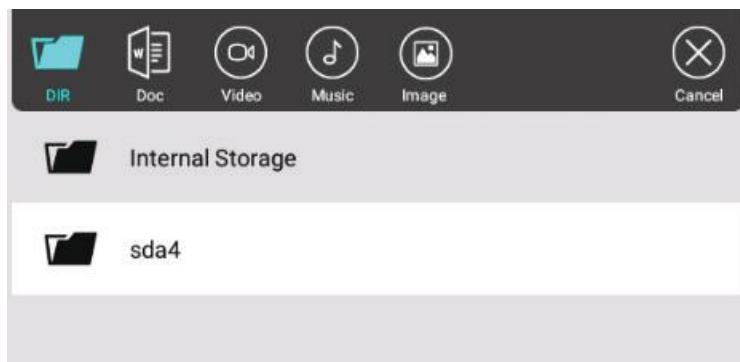
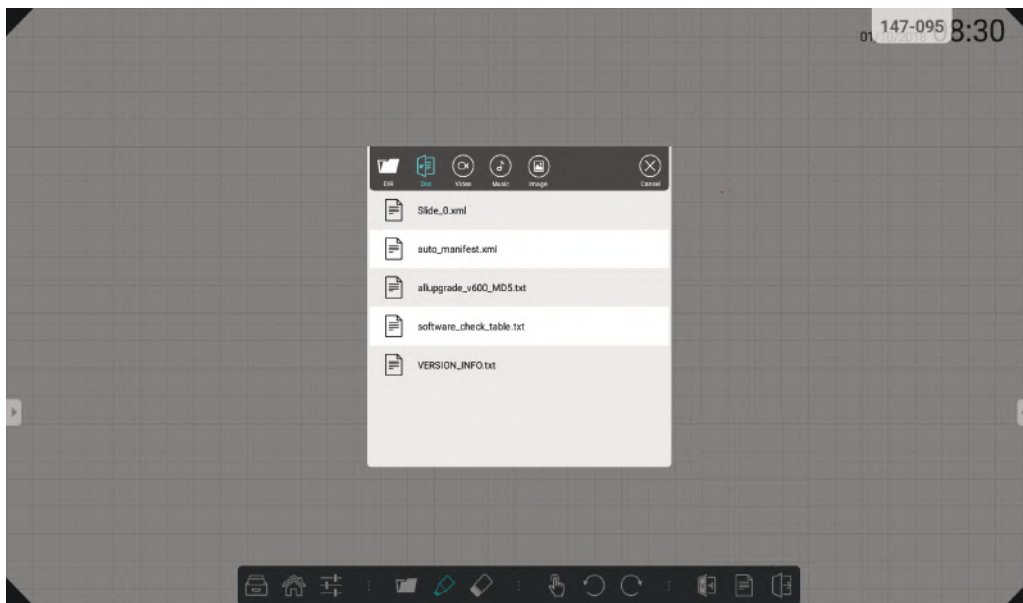

Open Document: click  to open document and content files



-  Click to view document directory
-  Select document in vBoard format
-  Import video into vBoard
-  Import audio into vBoard
-  Import image file into vBoard



- Page: click   to conduct page management . Press page number to preview or select a page.



Click the page to move to

Hold on a one then move it between pages.

## 5.2 ViewBoard Cast

ViewBoard Cast is the built-in wireless screen sharing receiver app within ViewBoard that allow users to cast in their presentation content, including mirroring screen content, images, videos, and audios. Before use ViewBoard Cast function, please be noted that proper network infrastructure setting is required.

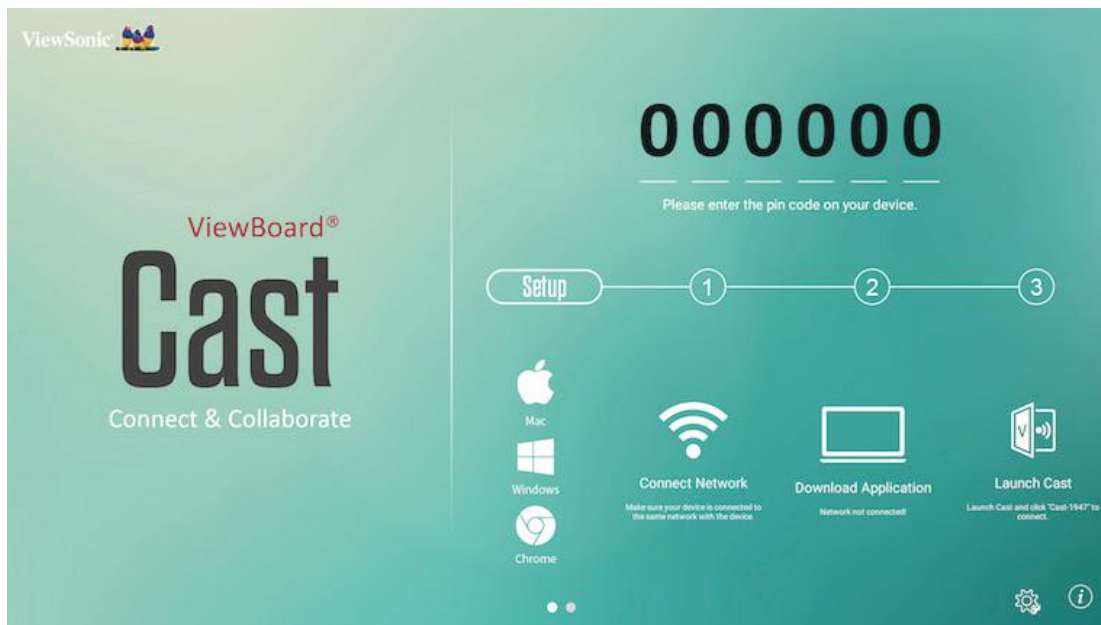

ViewBoard Cast is the wireless peer to peer data communication so that a proper ports setting is required.

Ports:

- TCP: 56789, 25123, 8121, and 8000 ports
- UDP: 48689, 25123

Port for activation:

- Port: 8001

[Remark] please be noted that screen sharing or video casting in/out is highly dependant on the each school's or corporate's IT network configuration and WiFi network bandwidth. The variation might be cause from internal network speed, routing, WiFi configuration, and QoS setting. Please consult your IT for related details.

## 5.2.1 Cast sender from Windows-based devices, Macbook, and Chrome devices

### Mac, Windows and Chrome devices

1. Make sure your device was connected to the same network with IFP.
2. Visit the address that shown on IFP to download application.
3. Launch ViewBoard Cast and click the icon number that shown on IFP.

## 5.2.2 Viewboard Cast sender from mobile devices: iOS-based (iPhone, iPad) and Android OS based phone/tablet



### iOS

**Step 1:** Make sure your device was connected to the same network with IFP.

**Step 2:** Enter password that shown on IFP.

**Step 3:** Slide up at the bottom enter the quick set Open AirPlay.

**Step 4:** Select the device, then the iOS operate interface will appear.

### Android

**Step 1:** Make sure your device was connected to the same network with IFP.







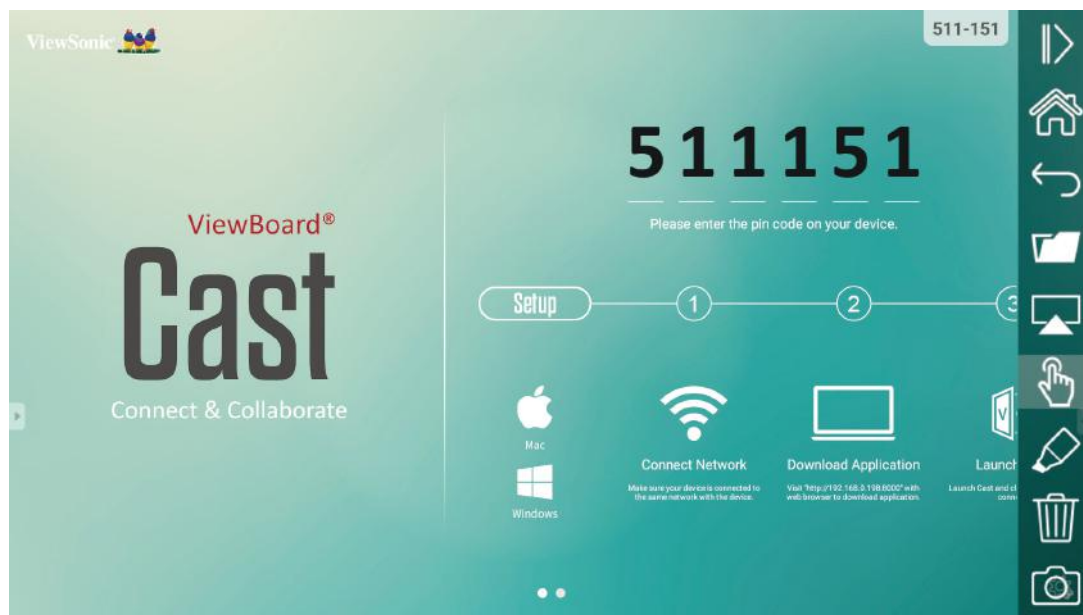

**Step 2:** Enter password that shown on IFP.

**Step 3:** Scan the QR code that shown on IFP to download the client.

**Step 4:** Open the ViewBoard Cast client.

### 5.2.3 ViewBoard Cast out from mobile device will support annotation function



Item	Description
 Toggle	Click to hide or display tool bar
 Home	Click to return to home interface
 Return	Click to return to previous operation interface
 Folder	Click to view or open mobile device internal file
 Screen sharing	Click to share screen (Android 5.0 above supported)
 Touch	Click to change to touch mode
 Pen	Click to make annotation in the picture Click to change color or thickness
 Clear	Click to clean all the elements
 Camera	Click to use camera then send the image to IFP50

**Note:** When play a video from iOS and Android device and share the screen to smart ViewBoard, the video would show on ViewBoard only.

## 5.3 Other default apps

### Zoom

Click  to run Zoom application.

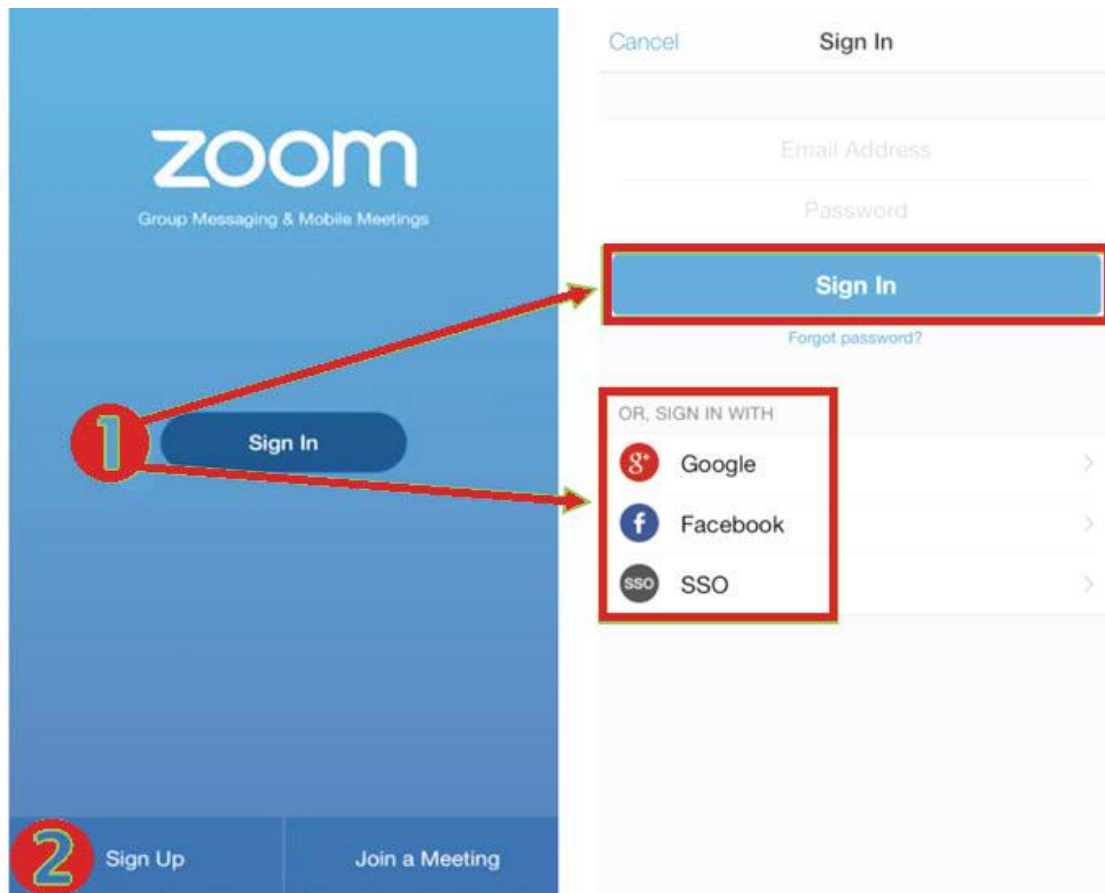

1. Click Sign In. Enter your email and password or sign in with your Google, Facebook or SSO account.
2. If you do not have a Zoom account, you should select Sign Up.

## Join a Meeting



1. Select Join a Meeting.
2. Enter the Meeting ID of the meeting you want to join.
3. Click Join Meeting.

## Start an Instant Meeting

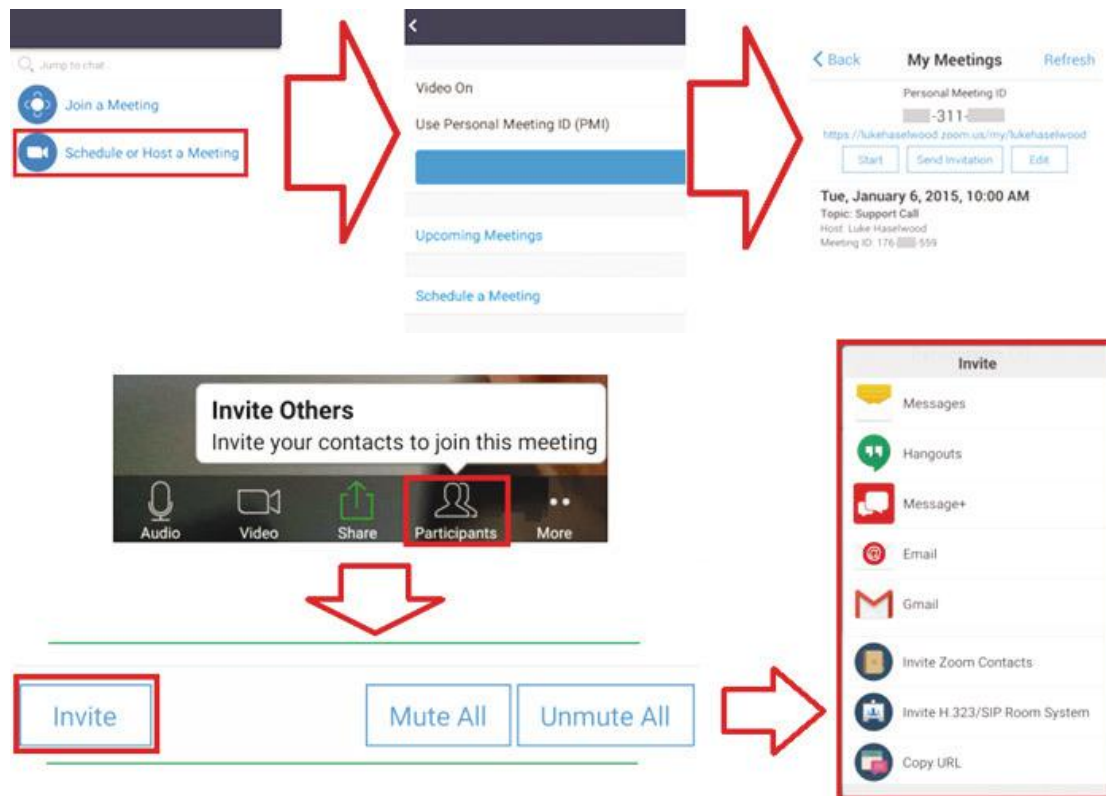

## Start an Instant Meeting

1. Select Schedule or Host a Meeting.
2. Choose the meeting options:
  - Choose to have Video On or off.
  - Choose to Use Personal Meeting ID or a unique meeting ID.
3. Click Start a Meeting.
4. Invite meeting participants by clicking the Participants icon at the bottom of the screen.
5. Click Invite at the bottom of the Participants screen.
6. Select the participants using the contact method you want to use for inviting participants.

## Browser

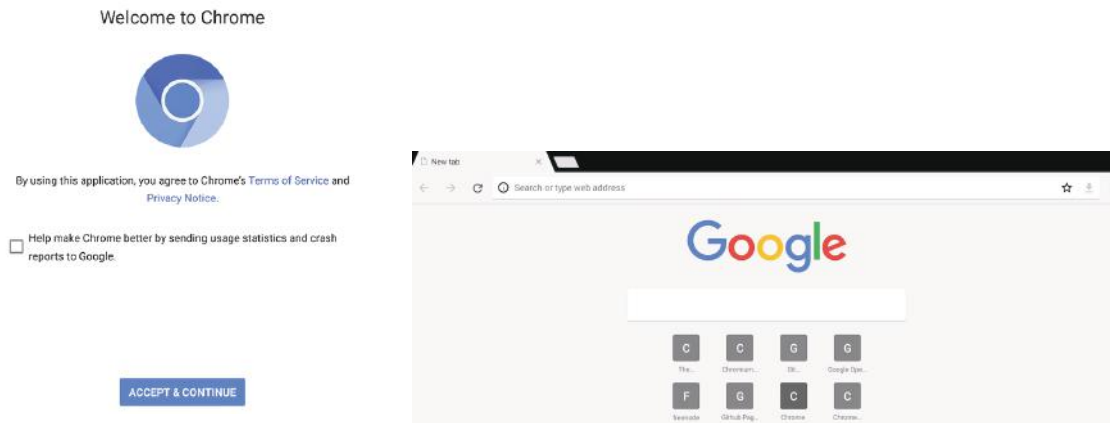

Enter web browser to surfing the internet.

## Folders

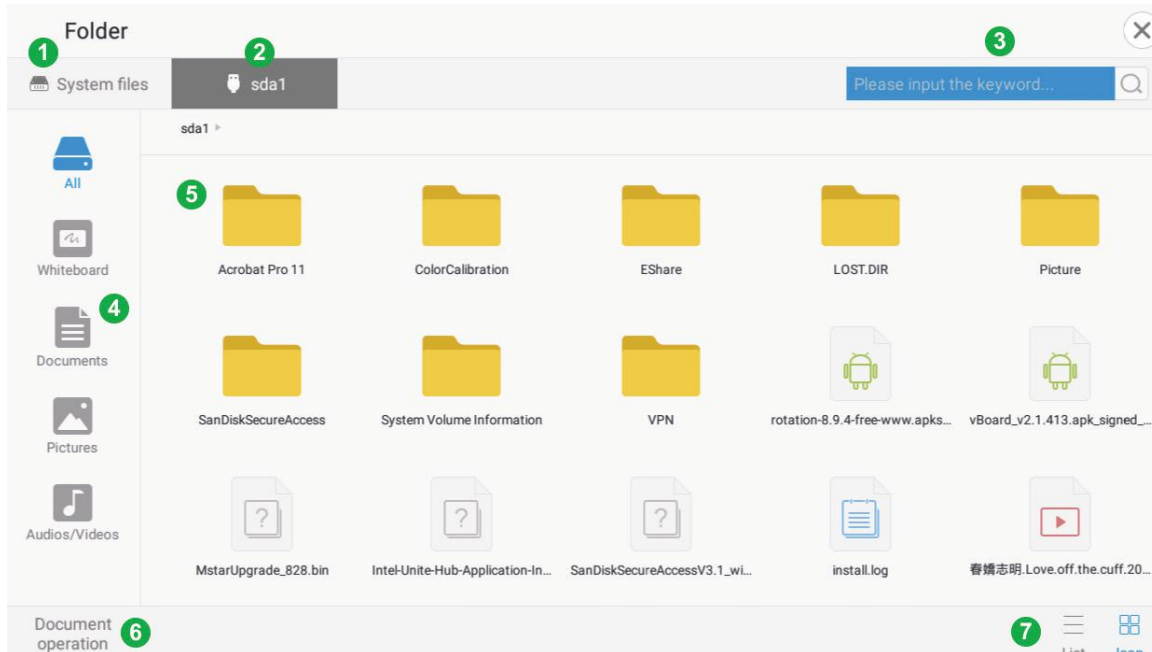

1. Local file location
2. USB storage
3. Search bar
4. File filter
5. Display area
6. Operator for copy, paste and delete
7. Change display view by list or grid



## 6. Trouble Shooting

Remote control is out of order	<ol style="list-style-type: none"> <li>1. Check whether something is obstructing the display's remote control receiver.</li> <li>2. Check whether the batteries in the remote control are installed correctly.</li> <li>3. Check whether the batteries need to be replaced.</li> </ol>
The unit turns of unexpectedly	<ol style="list-style-type: none"> <li>1. Check whether Sleep mode is enabled.</li> <li>2. Check if there is a power outage in your area.</li> <li>3. Turn on the display and see if the problem is with the signal and control system.</li> </ol>

### PC mode

No PC signal	<ol style="list-style-type: none"> <li>1. Check the display settings.</li> <li>2. Check the display resolution.</li> <li>3. Adjust the Hs &amp; Vs (synchronization) settings using the OSD menu.</li> </ol>
Background streaking	<ol style="list-style-type: none"> <li>1. Choose auto adjust.</li> <li>2. Adjust clock and phase.</li> </ol>
False color	<ol style="list-style-type: none"> <li>1. Check the VGA connection.</li> <li>2. Adjust chroma, brightness and contrast settings.</li> </ol>
Unsupported format	<ol style="list-style-type: none"> <li>1. Choose auto adjust.</li> <li>2. Adjust clock and phase settings.</li> </ol>

### Touch Function

Touch function does not work	<ol style="list-style-type: none"> <li>1. Check that drivers are installed correctly.</li> <li>2. Reinstall driver.</li> <li>3. Check setup and align it.</li> <li>4. Check whether the touch pen is working properly.</li> </ol>
------------------------------	---

### Video not working properly

No picture / No sound	<ol style="list-style-type: none"><li>1. Check POWER status.</li><li>2. Check the signal cable.</li><li>3. Check that the internal PC is installed correctly.</li></ol>
Picture trembling	<ol style="list-style-type: none"><li>1. Check the signal cable.</li><li>2. Check if other electronics are interrupting the signal.</li></ol>
Poor picture	<ol style="list-style-type: none"><li>1. Adjust chroma, brightness and contrast settings in the menu.</li><li>2. Check the signal cable.</li></ol>

### Audio not working properly

No sound	<ol style="list-style-type: none"><li>1. Press the Mute/ Unmute button.</li><li>2. Adjust the volume.</li><li>3. Check the audio cable.</li></ol>
One speaker only	<ol style="list-style-type: none"><li>1. Adjust the sound balance in the menu.</li><li>2. Check the sound control panel settings of the computer.</li><li>3. Check the audio cable.</li></ol>

## 7. Care and Maintenance

Please follow these cleaning guidelines to make sure your smart whiteboard display looks like new for years to come:

- Don't clean the machine if it has been turned on for a long period of time.
- Unplug the unit from the wall outlet before cleaning or polishing it.

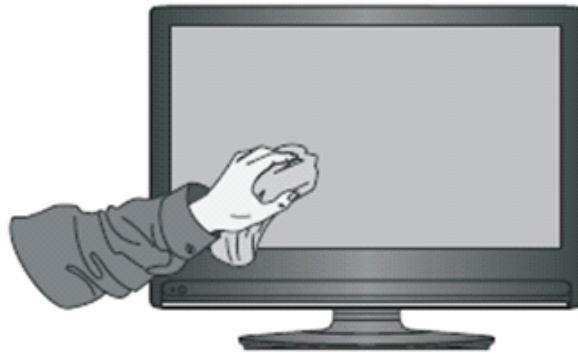

- Don't use liquid cleaners or aerosol cleaners on the screen.
- Only use a slightly dampened cloth when cleaning the exterior of the unit.
- Don't use system continuously for long periods of time.
- Remember to unplug the display when it is not in use.
- Use a power surge protector to prevent system failures and power supply surges.
- Make sure the display remains dry at all times. Be careful when handling liquids near or on the unit.

**Note:** If condensation appears between the glass and the panel, keep the display turned on until the moisture disappears.

# 8. Display Modes

## 8.1 VGA

640x480	@60Hz/72Hz/75Hz
720x400	@70Hz
800x600	@56Hz/60Hz/72Hz/75Hz
1024x768	@60Hz/70Hz/75Hz
1152x864	@60Hz/75Hz
1280x768	@60Hz/75Hz
1280x960	@60Hz
1280x1024	@60Hz/75Hz
1360x768	@60Hz
1366x768	@60Hz
1440x900	@60Hz
1400x1050	@60Hz
1600x1200	@60Hz
1680x1050	@60Hz
1920x1080	@60Hz
1920x1200	@60Hz

## 8.2 HDMI1/2/3/OPS/SDM

640x480	@60Hz/72Hz
720x400	@70Hz
800x600	@60Hz/72Hz
1024x768	@60Hz/70Hz/75Hz
1280x800	@60Hz
1280x1024	@60Hz
1360x768	@60Hz
1440x900	@60Hz
1680x1050	@60Hz
1920x1080	@60Hz
3840x2160	@30Hz (HDMI 1/SDM) @60Hz (HDMI 2/3/OPS)
480i	@60Hz
480p	@59Hz/60Hz
576i	@50Hz
720p	@50Hz/60Hz
576p	@50Hz
1080i	@50Hz/60Hz
1080p	@50Hz/60Hz

### 8.3 DP

640x480	@60Hz/72Hz
720x400	@70Hz
800x600	@60Hz/72Hz
1024x768	@60Hz/70Hz/75Hz
1280x800	@60Hz
1280x1024	@60Hz
1360x768	@60Hz
1440x900	@60Hz
1680x1050	@60Hz
1920x1080	@60Hz
3840x2160	@30Hz
3840x2160	@60Hz
480p	@59Hz/60Hz
720p	@50Hz/60Hz
576p	@50Hz
1080i	@50Hz/60Hz
1080p	@50Hz/60Hz

## 9. Specifications

		IFP6560	IFP7560
Screen Size		64.5"	74.5"
I/O port	HDMI In	Front HDMI 1.4a x1 (4K@30HZ) , HDCP1.4 Rear HDMI 2.0 x2 (4K@60HZ) , HDCP2.2	
	HDMI out	HDMI 2.0 x1 (720*480_60Hz/1920*1080_60Hz/3840*2160_60HZ) Not support 3D,CEC,ARC,HEC/CDC/Network/HDCP	
	VGA In	1 (up to 1920x1080)	
	DP In	DP1.2, up to 38400x 2160	
	Audio In	3.5mm x1	
	Mic In	1	
	RS-232 In	9 Pins RS232	
	Earphone Out	3.5mm x1	
	LAN	x1 , 10/100	
	Touch USB	Type-B x2	
	USB	Front USB2.0*2 for all port Back USB3.0*2, USB2.0*1 for Embed Player	
Speaker		10W x 2	
Power	Voltage	100V-240V AC050/60Hz	
	Consumption	Without OPS: 210W With OPS: 270W Off ≤ 0.5W  *Max power consumption from OPS doesn't over 60W	Without OPS&SDM: 297W With SDM but without OPS: 327W With OPS but without SDM: 357W With OPS&SDM: 397W Off ≤ 0.5W  *Max power consumption from OPS & SDM doesn't over 90W
Operation Condition	Temperature Humidity	Operating: 0°C ~ 40°C, Need Fanless design 20% ~ 80% RH Non-Condensing	
Storage Condition	Temperature Humidity Temperature	-20~+60 deg C @ 10%~90% 10%~90%, vacuumed package with drier	
Dimension(mm)		1565.5X967.1X94.5	1789.5X1094.5X108.1
Weight	Physical(Kg)	48.5 Kg±1.5Kg	62.5 Kg±1.5Kg

**Note:** Product Specifications are subject to change without notice.

# 10. RS-232 Protocol

## 10.1 Introduction

This document describes the hardware interface spec and software protocols of RS232 interface communication between ViewSonic LFD and PC or other control unit with RS232 protocol.

The protocol contains three sections command:

- Set-Function
- Get-Function
- Remote control pass-through mode

※ In the document below, “PC” represents all the control units that can send or receive the RS232 protocol command.

## 10.2 Description

### 10.2.1 Hardware Specification

ViewSonic LFD communication port on the rear side

(1) Connector type: DSUB 9-Pin Male (or 3.5mm barrel connector)

(2) Pin Assignment

(3) Use of crossover (null modem) cable for connection

Male DSUB 9-Pin



Pin #	Signal	Remark
1	NC	
2	RXD	Input to Display
3	TXD	Output from Display
4	NC	
5	GND	
6	NC	
7	NC	
8	NC	
9	NC	
frame	GND	



3.5mm barrel connector  
(alternative for limited  
space)



Pin #	Signal	Remark
Tip	TXD	Output from Display
Ring	RXD	Input to Display
Sleeve	GND	

### 10.2.2 LAN Hardware Specification

ViewSonic LFD communication port on the rear side

(1) Connector type: 8P8C RJ45

(2) Pin Assignment

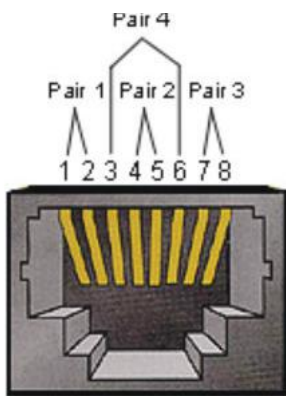

Pin #	Signal	Remark
1	TX+	Output from Display
2	TX-	Output from Display
3	RX+	Input to Display
4	BI_D3+	For 1G case
5	BI_D3-	For 1G case
6	RX-	Input to Display
7	BI_D4+	For 1G case
8	BI_D4-	For 1G case
frame	GND	

### 10.2.3 RS232 Communication Setting

- Baud Rate Select: 9600bps (fixed)
- Data bits: 8 bits (fixed)
- Parity: None (fixed)
- Stop Bits: 1(fixed)

### 10.2.4 LAN Communication Setting

- Type: Ethernet
- Protocol: TCP/IP
- Port: 5000 (fixed)
- Cross subnet: No
- Logon Credentials: No

### 10.2.5 Command Message Reference

PC sends to LFD command packet followed by "CR". Every time PC sends control command to Display, the Display shall respond as follows:

1. If the message is received correctly it will send "+" (02Bh) followed by "CR" (00Dh)
2. If the message is received incorrectly it will send "-" (02Dh) followed by "CR" (00Dh)

## 10.3 Protocol

### 10.3.1 Set-Function Listing

The PC can control the Display for specific actions. The Set-Function command allows you to control the Display behavior in a remote site through the RS232 port. The Set-Function packet format consists of 9 bytes.

#### Set-Function description:

<b>Length:</b>	Total Byte of Message excluding "CR"
<b>LFD ID</b>	Identification for each of Display (01~98; default is 01) ID "99" means to apply the set command for all connected displays. Under such circumstances, only ID#1 display has to reply. The LFD ID can be set via the OSD menu for each Display.
<b>Command Type</b>	Identify command type, "s" (0x73h): Set Command "+" (0x2Bh): Valid command Reply "- " (0x2Dh): Invalid command Reply
<b>Command:</b>	Function command code: One byte ASCII code.
<b>Value[1~3]:</b>	Three bytes ASCII that defines the value.
<b>CR</b>	0x0D

**Set-Function format****Send: (Command Type="s")**

Name	Length	ID	Command Type	Command	Value1	Value2	Value3	CR
Byte Count	1 Byte	2 Byte	1 Byte	1 Byte	1 Byte	1 Byte	1 Byte	1 Byte
Bytes order	1	2~3	4	5	6	7	8	9

**Reply: (Command Type="+" or "-")**

Name	Length	ID	Command Type	CR
Byte Count	1 Byte	2 Byte	1 Byte	1 Byte
Bytes order	1	2~3	4	5

**NOTE:**

1. When PC applies command to all displays (ID=99), only the #1 set needs to reply by the name of ID=1.

**Example1: Set Brightness as 76 for Display (#02) and this command is valid****Send (Hex Format)**

Name	Length	ID	Command Type	Command	Value1	Value2	Value3	CR
Hex	<u>0x38</u>	<u>0x30</u> <u>0x32</u>	<u>0x73</u>	<u>0x24</u>	<u>0x30</u>	<u>0x37</u>	<u>0x36</u>	<u>0x0D</u>

**Reply (Hex Format)**

Name	Length	ID	Command Type	CR
Hex	<u>0x34</u>	<u>0x30</u> <u>0x32</u>	<u>0x2B</u>	<u>0x0D</u>

**Example2: Set Brightness as 75 for Display (#02) and this command is NOT valid**

Name	Length	ID	Command Type	Command	Value1	Value2	Value3	CR
Hex	<u>0x38</u>	<u>0x30</u> <u>0x32</u>	<u>0x73</u>	<u>0x24</u>	<u>0x30</u>	<u>0x37</u>	<u>0x35</u>	<u>0x0D</u>

## Reply (Hex Format)

Name	Length	ID	Command Type	CR
Hex	<u>0x34</u>	<u>0x30</u> <u>0x32</u>	<u>0x2D</u>	<u>0x0D</u>

## Set-function table

### A. Basic function

Set Function	Length	ID	Command Type (ASCII)	Command		Value Range (Three ASCII bytes)	Comments
				Code (ASCII)	Code (Hex)		
Power on/ off (standby)	8		s	!	21	000: STBY 001: ON	The Power-on via LAN control may works only under specific mode. To see display UG for details. *3.1.1
Input Select	8		s	"	22	000: TV 001: AV 002: S-Video 003: YPbPr 004: HDMI1 014: HDMI2 024: HDMI3 034: HDMI4  005: DVI 006: VGA1 016: VGA2 026: VGA3  007: Slot-in PC (OPS/SDM)/HDBT  008: Internal memory 009: DP  00A: Embedded/ Main (Android)	1. No need for USB 2. For the case of two more same sources, the 2nd digital is used to indicate the extension. 3. The HEX of 00A is 30 30 41.
Brightness	8		s	\$	24	000 ~ 100 900: Bright down (-1) 901: Bright up (+1) *3.1.1	
Power lock	8		s	4	34	000: Unlock 001: Lock	*See note in details
Volume	8		s	5	35	000 ~ 100 900: Volume down(-1) 901:Volume up(+1)	
Mute	8		s	6	36	000: OFF 001: ON (mute)	
Button lock	8		s	8	38	000: Unlock 001: Lock	*See note in details
Menu lock		8		s	>	000: Unlock 001: Lock	*See note in details

Number *3.1.1	8		s	@	40	000~009	
Key Pad *3.1.1	8		s	A	41	000: UP 001: DOWN 002: LEFT 003: RIGHT 004: ENTER 005: INPUT 006: MENU/(EXIT) 007: EXIT	
Remote Control	8		s	B	42	000: Disable 001: Enable 002: Pass through	<b>Disable:</b> RCU will be no function <b>Enabled:</b> RCU controls normally <b>Pass through:</b> Display will bypass the RC code to connected device via the RS232 port, but not react itself.
Restore default	8		s	~	7E	000	Recover to factory setting

## NOTE:

### 1. Behavior at lock modes

Lock Mode	Behavior
Button Lock	<ol style="list-style-type: none"> <li>Lock all buttons on the front panel and RCU, except for "Power"</li> <li>All the SET functions should be workable via RS32, even the ones with according hot key in RCU like Mute,...etc.</li> </ol>
MENU Lock	<ol style="list-style-type: none"> <li>Lock "MENU" key of front panel and RCU</li> <li>The Factory and Hospitality modes should not be blocked for the model using MENU-combined key to enter these two modes. Alternative approach will be indicated separately if any limitation by model.</li> </ol>
POWER Lock	<ol style="list-style-type: none"> <li>Lock "POWER" key on the front and RCU.</li> <li>The SET_POWER on/off should be workable via RS232, but does not mean the POWER lock will be released under this case.</li> <li>Can not be unlocked by reset in OSD setting</li> <li>Will auto AC power-on in power-lock</li> <li>Under power-lock, the set will not enter power saving when no PC signal and neither not turn off when no other video signals after 15min.</li> </ol>
Remote control disable	Lock the RCU keys, but keep the front panel buttons workable.

## B. Optional function

Set Function	Length	ID	Command Type (ASCII)	Command		Value Range (Three ASCII bytes)	Comments
				Code (ASCII)	Code (Hex)		
Contrast	8		s	#	23	000 ~ 100	
Sharpness	8		s	%	25	000 ~ 100	
Color	8		s	&	26	000 ~ 100	
Tint	8		s	'	27	000 ~ 100	
Color mode	8		s	)	29	000: Normal 001: Warm 002: Cold 003: Personal	
Surround sound	8		s	-	2D	000: OFF 001: ON	
Bass	8		s	.	2E	000 ~ 100	
Treble	8		s	/	2F	000 ~ 100	
Balance	8		s	0	30	000 ~ 100	050 is central
Picture Size	8		s	1	31	000: FULL (16:9) 001: NORMAL (4:3) 002: REAL (1:1) *3.1.0	
OSD language	8		s	2	32	000: English 001: French 002: Spanish	Could be extended for more supported languages by model
PIP-Mode	8		s	9	39	000: OFF 001: PIP(POP) 002: PBP	
PIP-Sound select	8		s	:	3A	000: Main 001: Sub	
PIP-Position	8		s	;	3B	000: Up 001: Down 002: Left 003: Right	
PIP-Input	8		s	7	37 *2.9	000: TV 001: AV 002: S-Video 003: YPbPr 004: HDMI1 014: HDMI2 024: HDMI3 034: HDMI4  005: DVI 006: VGA1 016: VGA2 026: VGA3  007: Slot-in PC (OPS/SDM)/HDBT 008: Internal memory 009: DP  00A: Embedded/ Main (Android)	Value range is same as SET-Input select

Tiling-Mode	8		s	P	50	000: OFF 001: ON	(for video wall)
Tiling-Compensation	8		s	Q	51	000: OFF 001: ON	(for video wall) Bezel width compensation
Tiling-H by V Monitors	8		s	R	52	01x~09x: H 0x1~0x9: V	(for video wall) 1. 2nd digital for H monitors 2. 3rd digital for V monitors
Tiling-Position	8		s	S	53	001~025	(for Video wall) Copy the screen of Position# to identified display
Date: Year	8		s	V	56	Y17~Y99	Last 2 digits (20)17~(20)99
Date: Month	8		s	V	56	M01~M12	2 digits
Date: Day	8		s	V	56	D01~D31	2 digits
Time: Hour	8		s	W	57	H00~H23	24-hr format. 2 digits.
Time: Min	8		s	W	57	M00~M59	2 digits
Time: Sec	8		s	W	57	S00~S59	2 digits

**Note:**

**1. Tiling definition of H Monitors/ V Monitors/ and Position**

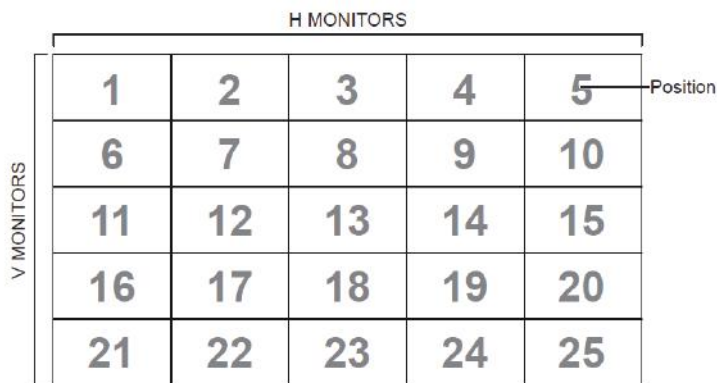

**2. Set Date example**

Date: 2017-3/15

Send: 0x 38 30 31 73 56 59 31 37 0D ("Y17")

Send: 0x 38 30 31 73 56 4D 30 33 0D ("M03")

Send: 0x 38 30 31 73 56 44 31 35 0D ("D15")

### 3. Set Time example

Time: 16:27:59

Send: 0x 38 30 31 73 57 48 31 36 0D (“H16”)

Send: 0x 38 30 31 73 57 4D 32 37 0D (“M27”)

Send: 0x 38 30 31 73 57 53 35 39 0D (“S59”)

### 10.3.2 Get-Function Listing

The PC can interrogate the LFD for specific information. The Get-Function packet format consists of 9 bytes which is similar to the Set-Function packet structure. Note that the “Value” byte is always = 000

#### Get-Function description:

**Length:** Total Byte of Message excluding “CR”.

**TV/DS ID** Identification for each of TV/DS (01~98; default is 01).

**Command Type** Identify command type,  
 “g” (0x67h) : Get Command  
 “r” (0x72h) : Valid command Reply  
 “-“ (0x2Dh) : Invalid command Reply

**Command:** Function command code: One byte ASCII code.

**Value[1~3]:** Three bytes ASCII that defines the value.

**CR** 0x0D

#### Get-Function format

**Send: (Command Type=“g”)**

Name	Length	ID	Command Type	Command	Value1	Value2	Value3	CR
Byte Count	1 Byte	2 Byte	1 Byte	1 Byte	1 Byte	1 Byte	1 Byte	1 Byte
Bytes order	1	2~3	4	5	6	7	8	9

#### Reply: (Command Type=“r” or “-“)

**If the Command is valid, Command Type =“r”**

Name	Length	ID	Command Type	Command	Value1	Value2	Value3	CR
Byte Count	1 Byte	2 Byte	1 Byte	1 Byte	1 Byte	1 Byte	1 Byte	1 Byte



Bytes order	1	2~3	4	5	6	7	8	9
-------------	---	-----	---	---	---	---	---	---

**If the Command is Not valid, Command Type="-"**

Name	Length	ID	Command Type	CR
Byte Count	1 Byte	2 Byte	1 Byte	1 Byte
Bytes order	1	2~3	4	5

**Example1: Get Brightness from TV-05 and this command is valid.  
The Brightness value is 67.**

**Send (Hex Format)**

Name	Length	ID	Command Type	Command	Value1	Value2	Value3	CR
Hex	<u>0x38</u>	<u>0x30</u> <u>0x35</u>	<u>0x67</u>	<u>0x62</u>	<u>0x30</u>	<u>0x30</u>	<u>0x30</u>	<u>0x0D</u>

**Reply (Hex Format)**

Name	Length	ID	Command Type	Command	Value1	Value2	Value3	CR
Hex	<u>0x38</u>	<u>0x30</u> <u>0x35</u>	<u>0x72</u>	<u>0x62</u>	<u>0x30</u>	<u>0x36</u>	<u>0x37</u>	<u>0x0D</u>

**Example2: Get Color from Display (#05) , but the Color command is not supported by this model.**

**Send (Hex Format)**

Name	Length	ID	Command Type	Command	Value1	Value2	Value3	CR
Hex	<u>0x38</u>	<u>0x30</u> <u>0x35</u>	<u>0x67</u>	<u>0x26</u>	<u>0x30</u>	<u>0x30</u>	<u>0x30</u>	<u>0x0D</u>

**Reply (Hex Format)**

Name	Length	ID	Command Type	CR
Hex	<u>0x34</u>	<u>0x30</u> <u>0x35</u>	<u>0x2D</u>	<u>0x0D</u>

## Get-Function table

### A. Basic function

Get Function	Length	ID	Command Type (ASCII)	Command		Response Range (Three ASCII bytes)	Comments
				Code (ASCII)	Code (Hex)		
Get-Brightness	8		g	b	62	000 ~ 100	
Get-Volume	8		g	f	66	000 ~ 100	
Get-Mute	8		g	g	67	000: Off 001: On (muted)	
Get-Input select	8		g	j	6A	000~ 100~	1. 1st digit for signal detection: 0 means "no signal"; 1 means "signal detected" 2. 2nd & 3rd digit: See Set-function table
Get-Power status: ON/STBY	8		g	l	6C	001: ON 000: STBY	
Get-Remote control	S		g	n	6E	000: Disable 001: Enable 002: Pass through	Get RCU mode status
Get-Power lock	8		g	o	6F	000: Unlock 001: Lock	
Get-Button lock	8		g	p	70	000: Unlock 001: Lock	
Get-Menu lock	8		g	l	6C	000: Unlock 001: Lock	
Get-ACK	8		g	z	7A	000	This command is used to test the communication link
Get-Thermal	8		g	0	30	000~100: 0~+100 deg C -01~-99: -1~-99 deg C	
Get-Operation time*3.1.0	8		g	1	31	000	1. Accumulated hours in 8-digit integer (00,000,001~99,999,999) 2. Could be reset when FW update and Factory initiation 3. Reply in 4 strings
Get-Device name	8		g	4	34	000	Reply in 6 strings (max. 12 characters) *3.1.0
Get-MAC address	8		g	5	35	000	(for the model with LAN) Reply in 6 strings.*3.1.0

## NOTE:

### 1. Get Operation time example

Assumed the accumulated operation time is 00,123,456 hrs

Send: 0x 38 30 31 67 31 30 30 30 0D (Get Operation time)

Reply:

#1 0x 38 30 31 72 31 31 30 30 0D ("00")

#2 0x 38 30 31 72 31 32 31 32 0D ("12")

#3 0x 38 30 31 72 31 33 33 34 0D ("34")

#4 0x 38 30 31 72 31 34 35 36 0D ("56")

### 2. Get Device Name example

Assumed the device name is CDE-5500

Send: 0x 38 30 31 67 34 30 30 30 0D (Get Device Name)

Reply:

#1 0x 38 30 31 72 34 31 43 44 0D ("C" "D")

#2 0x 38 30 31 72 34 32 45 2D 0D ("E" "-")

#3 0x 38 30 31 72 34 33 35 35 0D ("5" "5")

#4 0x 38 30 31 72 34 34 30 30 0D ("0" "0")

#5 0x 38 30 31 72 34 35 00 00 0D ("(NULL)" "(NULL)")

#6 0x 38 30 31 72 34 36 00 00 0D ("(NULL)" "(NULL)")

Assumed the device name is "NMP-302#1"

Send: 0x 38 30 31 67 34 30 30 30 0D (Get Device Name)

Reply:

#1 0x 38 30 31 72 34 31 4E 4D 0D ("N" "M")

#2 0x 38 30 31 72 34 32 50 2D 0D ("P" "-")

#3 0x 38 30 31 72 34 33 33 30 0D ("3" "0")

#4 0x 38 30 31 72 34 34 32 23 0D ("2" "#")

#5 0x 38 30 31 72 34 35 31 00 0D ("1" "(NULL)")

#6 0x 38 30 31 72 34 36 00 00 0D ("(NULL)" "(NULL)")

### 3. Get MAC address example

Assumed the MAC address is 00:11:22:aa:bb:cc

Send: 0x 38 30 31 67 35 30 30 30 0D (Get MAC add)

Reply:

#1 0x 38 30 31 72 35 31 30 30 0D ("00")

#2 0x 38 30 31 72 35 32 31 31 0D ("11")

#3 0x 38 30 31 72 35 33 32 32 0D ("22")

#4 0x 38 30 31 72 35 34 61 61 0D ("aa")

#5 0x 38 30 31 72 35 35 62 62 0D ("bb")

#6 0x 38 30 31 72 35 36 63 63 0D ("cc")

## B. Optional function

Get Function	Length	ID	Command Type (ASCII)	Command		Response Range (Three ASCII bytes)	Comments
				Code (ASCII)	Code (Hex)		
Get-Contrast	8		g	a	61	000 ~ 100	
Get-Sharpness	8		g	c	63	000 ~ 100	
Get-Color	8		g	d	64	000 ~ 100	
Get-Tint	8		g	e	65	000 ~ 100	
Get-PIP mode	8		g	t	74	000: OFF 001: PIP (POP) 002: PBP	
Get-PIP input	8		g	u	75	000 ~	See Set-input select
Get-Tiling Mode	8		g	v	76	000: OFF 001: ON	(for Video wall)
Get-Tiling Compensation	8		g	w	77	000: OFF 001: ON	(for Video wall) Bezel width compensation
Get-Tiling H by V monitors	8		g	x	78	01x~09x: H monitors 0x1~0x9: V monitors	(for Video wall) 1. 2nd digital for H monitors 2. 3rd digital for V monitors
Get-Tiling position	8		g	y	79	000: OFF 001~025	(for Video wall) Copy the screen of Position# to identified display
Get-Date: Year	8		g	2	32	Y00~Y00	Last 2 digits (20)17~(20)99
Get-Date: Month	8		g	2	32	M00~M00	2 digits
Get-Date: Day	8		g	2	32	D00~M00	2 digits
Get-Time: Hour	8		g	3	33	H00~H00	24-hr format. 2 digits
Get-Time: Min	8		g	3	33	M00~M00	2 digits
Get-Time: Sec	8		g	3	33	S00~S00	2 digits
Get-RS232 version	8		g	6	36	001~	Version 0.0.1~9.9.9

### NOTE:

#### 1. Get Date example

Assumed the current date of display#01 as below

Date: 2017-3/15

Send: 0x 38 30 31 67 32 59 30 30 0D (Get Date:Year)

Reply: 0x 38 30 31 72 32 59 31 37 0D ("Y17")

Send: 0x 38 30 31 67 32 4D 30 30 0D (Get Date:Month)

Reply: 0x 38 30 31 72 32 4D 30 33 0D ("M03")

Send: 0x 38 30 31 67 32 44 30 30 0D (Get Date:Day)  
Reply: 0x 38 30 31 72 32 44 31 35 0D ("D15")

## 2. Get Time example

Assumed the current time of display#01 as below

Time: 16:27:59

Send: 0x 38 30 31 67 33 48 30 30 0D (Get Time:Hour)  
Reply: 0x 38 30 31 72 33 48 31 36 0D ("H16")

Send: 0x 38 30 31 67 33 4D 30 30 0D (Get Time:Min)  
Reply: 0x 38 30 31 72 33 4D 32 37 0D ("M27")

Send: 0x 38 30 31 67 33 53 30 30 0D (Get Time:Sec)  
Reply: 0x 38 30 31 72 33 53 35 39 0D ("S59")

## 3. Get MAC address example

Assumed the version is 3.0.1

Send: 0x 38 30 31 67 36 30 30 30 0D (Get RS232 version)  
Reply: 0x 38 30 31 72 36 33 30 31 0D ("301")

### 10.3.3 Remote Control Pass-through Mode

When PC sets the Display to Remote Control Pass through mode, the Display shall send a 7-byte packet (followed by “CR”) in response to RCU button activation. In this mode the RCU shall have no effect on the Display function. For example: “Volume+” will not change the volume in the Display but only sends “Volume+” code to PC over the RS232 port.

#### IR Pass Through-Function format

Reply: (Command Type=“p”)

Name	Length	ID	Command Type	RCU Code1 (MSB)	RCU Code2 (LSB)	CR
Byte Count	1 Byte	2 Byte	1 Byte	1 Byte	1 Byte	1 Byte
Bytes order	1	2~3	4	5	6	7

#### Example1: Remote Control pass-through when “VOL+” key is pressed for Display (#5)

Send (Hex Format)

Name	Length	ID	Command Type	RCU Code1 (MSB)	RCU Code2 (LSB)	CR
Hex	<u>0x36</u>	<u>0x30</u> <u>0x35</u>	<u>0x70</u>	<u>0x31</u>	<u>0x30</u>	<u>0x0D</u>

Key	Code (HEX)	Basic *3.1.1	Optional *3.1.1
1	01	V	
2	02	V	
3	03	V	
4	04	V	
5	05	V	
6	06	V	
7	07	V	
8	08	V	
9	09	V	
0	0A	V	
-	0B		V
RECALL (LAST)	0C		V
INFO (DISPLAY)	0D		V
	0E		
ASPECT (ZOOM, SIZE)	0F		V
VOLUME UP (+)	10	V	
VOLUME DOWN (-)	11	V	
MUTE	12	V	
CHANNEL/PAGE UP (+)/ BRIGHTNESS+	13		V

CHANNEL/PAGE DOWN (-)/ BRIGHTNESS-	14		V
POWER	15	V	
SOURCES (INPUTS)	16	V	
	17		
	18		
SLEEP	19		V
MENU	1A	V	
UP	1B	V	
DOWN	1C	V	
LEFT (-)	1D	V	
RIGHT (+)	1E	V	
OK (ENTER, SET)	1F	V	
EXIT	20	V	
	21		
	22		
	23		
	24		
	25		
	26		
	27		
	28		
	29		
	2A		
	2B		
RED■ (F1)	2C		V
GREEN■ (F2)	2D		V
YELLOW■ (F3)	2E		V
BLUE■ (F4)	2F		V
CHANNEL/PAGE DOWN (-)/ BRIGHTNESS-	14		
POWER	15		
SOURCES (INPUTS)	16		
	17		
	18		
SLEEP	19		
MENU	1A		
UP	1B		
DOWN	1C		
LEFT (-)	1D		
RIGHT (+)	1E		
OK (ENTER, SET)	1F		
EXIT	20		
	21		
	22		
	23		
	24		
	25		

	26		
	27		
	28		
	29		
	2A		
	2B		
RED ■ (F1)	2C		
GREEN ■ (F2)	2D		
YELLOW ■ (F3)	2E		
BLUE ■ (F4)	2F		

**NOTE:**

1. This IR-pass-through code is different from the RCU key code.
2. Special control sequence for POWER key under IR-pass through mode.
  - 2-1. When Display is OFF and receives the IR POWER code: Display will turn itself on, then forward the POWER code to the host via RS232.
  - 2-2. When Display is ON and receives the IR POWER code: Display will forward the POWER code to the host via RS232, then turn off itself.
  - 2-3. When SET-POWER LOCK is enabled, the Display will not respond to POWER key pressing.
3. The VOLUME UP and VOLUME DOWN code will repeatedly output when you press and hold the keys.



# Warranty Statement

## Limited Warranty

### ViewSonic® Smart White Board

**What the warranty covers:**

ViewSonic warrants its products to be free from defects in material and workmanship, under normal use, during the warranty period. If a product proves to be defective in material or workmanship during the warranty period, ViewSonic will, at its sole option, repair or replace the product with a like product. Replacement product or parts may include remanufactured or refurbished parts or components.

**Who the warranty protects:**

This warranty is valid only for the first consumer purchaser.

**What the warranty does not cover:**

1. Any product on which the serial number has been defaced, modified or removed.
2. Damage, deterioration or malfunction resulting from:
  - a. Accident, misuse, neglect, fire, water, lightning, or other acts of nature, unauthorized product modification, or failure to follow instructions supplied with the product.
  - b. Any damage of the product due to shipment.
  - c. Removal or installation of the product.
  - d. Causes external to the product, such as electrical power fluctuations or failure.
  - e. Use of supplies or parts not meeting ViewSonic's specifications.
  - f. Normal wear and tear.
  - g. Any other cause which does not relate to a product defect.
3. Any product exhibiting a condition commonly known as "image burn-in" which results when a static image is displayed on the product for an extended period of time.
4. Removal, installation, one way transportation, insurance, and set-up service charges.

**How to get service:**

1. For information about receiving service under warranty, contact ViewSonic Customer Support (Please refer to Customer Support page). You will need to provide your product's serial number.
2. To obtain warranty service, you will be required to provide (a) the original dated sales slip, (b) your name, (c) your address, (d) a description of the problem, and (e) the serial number of the product.
3. Take or ship the product freight prepaid in the original container to an authorized ViewSonic service center or ViewSonic.
4. For additional information or the name of the nearest ViewSonic service center, contact ViewSonic.

**Limitation of implied warranties:**

There are no warranties, express or implied, which extend beyond the description contained herein including the implied warranty of merchantability and fitness for a particular purpose.

**Exclusion of damages:**

ViewSonic's liability is limited to the cost of repair or replacement of the product. ViewSonic shall not be liable for:

1. Damage to other property caused by any defects in the product, damages based upon inconvenience, loss of use of the product, loss of time, loss of profits, loss of business opportunity, loss of goodwill, interference with business relationships, or other commercial loss, even if advised of the possibility of such damages.
2. Any other damages, whether incidental, consequential or otherwise.
3. Any claim against the customer by any other party.
4. Repair or attempted repair by anyone not authorized by ViewSonic.

**Effect of state law:**

This warranty gives you specific legal rights, and you may also have other rights which vary from state to state. Some states do not allow limitations on implied warranties and/or do not allow the exclusion of incidental or consequential damages, so the above limitations and exclusions may not apply to you.

**Sales outside the U.S.A. and Canada:**

For warranty information and service on ViewSonic products sold outside of the U.S.A. and Canada, contact ViewSonic or your local ViewSonic dealer.

The warranty period for this product in mainland China (Hong Kong, Macao and Taiwan Excluded) is subject to the terms and conditions of the Maintenance Guarantee Card.

For users in Europe and Russia, full details of warranty provided can be found in [www.viewsoniceurope.com](http://www.viewsoniceurope.com) under Support/Warranty Information.

# Mexico Limited Warranty

## ViewSonic® Smart White Board

### What the warranty covers:

ViewSonic warrants its products to be free from defects in material and workmanship, under normal use, during the warranty period. If a product proves to be defective in material or workmanship during the warranty period, ViewSonic will, at its sole option, repair or replace the product with a like product. Replacement product or parts may include remanufactured or refurbished parts or components & accessories.

### Who the warranty protects:

This warranty is valid only for the first consumer purchaser.

### What the warranty does not cover:

1. Any product on which the serial number has been defaced, modified or removed.
2. Damage, deterioration or malfunction resulting from:
  - a. Accident, misuse, neglect, fire, water, lightning, or other acts of nature, unauthorized product modification, unauthorized attempted repair, or failure to follow instructions supplied with the product.
  - b. Any damage of the product due to shipment.
  - c. Causes external to the product, such as electrical power fluctuations or failure.
  - d. Use of supplies or parts not meeting ViewSonic's specifications.
  - e. Normal wear and tear.
  - f. Any other cause which does not relate to a product defect.
3. Any product exhibiting a condition commonly known as "image burn-in" which results when a static image is displayed on the product for an extended period of time.
4. Removal, installation, insurance, and set-up service charges.

### How to get service:

For information about receiving service under warranty, contact ViewSonic Customer Support (Please refer to the attached Customer Support page). You will need to provide your product's serial number, so please record the product information in the space provided below on your purchase for your future use. Please retain your receipt of proof of purchase to support your warranty claim.

For Your Records

Product Name: \_\_\_\_\_ Model Number: \_\_\_\_\_  
Document Number: \_\_\_\_\_ Serial Number: \_\_\_\_\_  
Purchase Date: \_\_\_\_\_ Extended Warranty Purchase? \_\_\_\_\_ (Y/N)  
If so, what date does warranty expire? \_\_\_\_\_

1. To obtain warranty service, you will be required to provide (a) the original dated sales slip, (b) your name, (c) your address, (d) a description of the problem, and (e) the serial number of the product.
2. Take or ship the product in the original container packaging to an authorized ViewSonic service center.
3. Round trip transportation costs for in-warranty products will be paid by ViewSonic.

### Limitation of implied warranties:

There are no warranties, express or implied, which extend beyond the description contained herein including the implied warranty of merchantability and fitness for a particular purpose.

### Exclusion of damages:

ViewSonic's liability is limited to the cost of repair or replacement of the product. ViewSonic shall not be liable for:

1. Damage to other property caused by any defects in the product, damages based upon inconvenience, loss of use of the product, loss of time, loss of profits, loss of business opportunity, loss of goodwill, interference with business relationships, or other commercial loss, even if advised of the possibility of such damages.
2. Any other damages, whether incidental, consequential or otherwise.
3. Any claim against the customer by any other party.
4. Repair or attempted repair by anyone not authorized by ViewSonic.

<b>Contact Information for Sales &amp; Authorized Service (Centro Autorizado de Servicio) within Mexico:</b>	
<b>Name, address, of manufacturer and importers:</b> México, Av. de la Palma #8 Piso 2 Despacho 203, Corporativo Interpalmas, Col. San Fernando Huixquilucan, Estado de México Tel: (55) 3605-1099 <a href="http://www.viewsonic.com/la/soporte/index.htm">http://www.viewsonic.com/la/soporte/index.htm</a>	
<b>NÚMERO GRATIS DE ASISTENCIA TÉCNICA PARA TODO MÉXICO: 001.866.823.2004</b>	
<b>Hermosillo:</b> Distribuciones y Servicios Computacionales SA de CV. Calle Juárez 284 local 2 Col. Bugambillas C.P: 83140 Tel: 01-66-22-14-9005 E-Mail: <a href="mailto:disc2@hmo.megared.net.mx">disc2@hmo.megared.net.mx</a>	<b>Villahermosa:</b> Compumantenimientos Garantizados, S.A. de C.V. AV. GREGORIO MENDEZ #1504 COL, FLORIDA C.P. 86040 Tel: 01 (993) 3 52 00 47 / 3522074 / 3 52 20 09 E-Mail: <a href="mailto:compumantenimientos@prodigy.net.mx">compumantenimientos@prodigy.net.mx</a>
<b>Puebla, Pue. (Matriz):</b> RENTA Y DATOS, S.A. DE C.V. Domicilio: 29 SUR 721 COL. LA PAZ 72160 PUEBLA, PUE. Tel: 01(52).222.891.55.77 CON 10 LINEAS E-Mail: <a href="mailto:datos@puebla.megared.net.mx">datos@puebla.megared.net.mx</a>	<b>Veracruz, Ver.:</b> CONEXION Y DESARROLLO, S.A DE C.V. Av. Americas # 419 ENTRE PINZÓN Y ALVARADO Fracc. Reforma C.P. 91919 Tel: 01-22-91-00-31-67 E-Mail: <a href="mailto:gacosta@qplus.com.mx">gacosta@qplus.com.mx</a>
<b>Chihuahua</b> Soluciones Globales en Computación C. Magisterio # 3321 Col. Magisterial Chihuahua, Chih. Tel: 4136954 E-Mail: <a href="mailto:Cefeo@soluglobales.com">Cefeo@soluglobales.com</a>	<b>Cuernavaca</b> Compusupport de Cuernavaca SA de CV Francisco Leyva # 178 Col. Miguel Hidalgo C.P. 62040, Cuernavaca Morelos Tel: 01 777 3180579 / 01 777 3124014 E-Mail: <a href="mailto:aquevedo@compusupportcva.com">aquevedo@compusupportcva.com</a>
<b>Distrito Federal:</b> QPLUS, S.A. de C.V. Av. Coyoacán 931 Col. Del Valle 03100, México, D.F. Tel: 01(52)55-50-00-27-35 E-Mail: <a href="mailto:gacosta@qplus.com.mx">gacosta@qplus.com.mx</a>	<b>Guadalajara, Jal.:</b> SERVICRECE, S.A. de C.V. Av. Niños Héroes # 2281 Col. Arcos Sur, Sector Juárez 44170, Guadalajara, Jalisco Tel: 01(52)33-36-15-15-43 E-Mail: <a href="mailto:mmiranda@servicrece.com">mmiranda@servicrece.com</a>
<b>Guerrero Acapulco</b> GS Computación (Grupo Sesicomp) Progreso #6-A, Colo Centro 39300 Acapulco, Guerrero Tel: 744-48-32627	<b>Monterrey:</b> Global Product Services Mar Caribe # 1987, Esquina con Golfo Pérsico Fracc. Bernardo Reyes, CP 64280 Monterrey N.L. México Tel: 8129-5103 E-Mail: <a href="mailto:aydeem@gps1.com.mx">aydeem@gps1.com.mx</a>
<b>MERIDA:</b> ELECTROSER Av Reforma No. 403Gx39 y 41 Mérida, Yucatán, México CP97000 Tel: (52) 999-925-1916 E-Mail: <a href="mailto:rrrb@sureste.com">rrrb@sureste.com</a>	<b>Oaxaca, Oax.:</b> CENTRO DE DISTRIBUCION Y SERVICIO, S.A. de C.V. Murguía # 708 P.A., Col. Centro, 68000, Oaxaca Tel: 01(52)95-15-15-22-22 Fax: 01(52)95-15-13-67-00 E-Mail: <a href="mailto:gpotai2001@hotmail.com">gpotai2001@hotmail.com</a>
<b>Tijuana:</b> STD Av Ferrocarril Sonora #3780 L-C Col 20 de Noviembre Tijuana, Mexico	<b>FOR USA SUPPORT:</b> ViewSonic Corporation 10 Pointe Dr. Suite 200. Brea, CA. 92821, UY.S.A Tel: 800-688-6688 (English); 866-323-8056 (Spanish); E-Mail: <a href="http://www.viewsonic.com">http://www.viewsonic.com</a>



**ViewSonic®**